

Ruijie Reyee RG-RAP62-OD Access Point

Implementation Cookbook

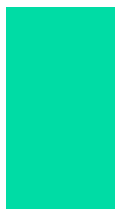
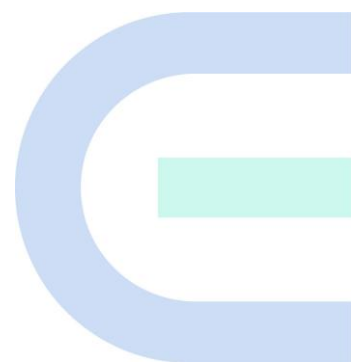

Copyright

Copyright © 2024 Ruijie Networks

All rights are reserved in this document and this statement.

Without the prior written consent of Ruijie Networks, any organization or individual shall not reproduce, extract, back up, modify, or propagate the content of this document in any manner or in any form, or translate it into other languages or use some or all parts of the document for commercial purposes.



and other Ruijie networks logos are trademarks of Ruijie Networks.

All other trademarks or registered trademarks mentioned in this document are owned by their respective owners.

Disclaimer

The products, services, or features you purchase are subject to commercial contracts and terms, and some or all of the products, services, or features described in this document may not be available for you to purchase or use. Except for the agreement in the contract, Ruijie Networks makes no explicit or implicit statements or warranties with respect to the content of this document.

The names, links, descriptions, screenshots, and any other information regarding third-party software mentioned in this document are provided for your reference only. Ruijie Networks does not explicitly or implicitly endorse or recommend the use of any third-party software and does not make any assurances or guarantees concerning the applicability, security, or legality of such software. You should choose and use third-party software based on your business requirements and obtain proper authorization. Ruijie Networks assumes no liability for any risks or damages arising from your use of third-party software.

The content of this document will be updated from time to time due to product version upgrades or other reasons, Ruijie Networks reserves the right to modify the content of the document without any notice or prompt.

This manual is designed merely as a user guide. Ruijie Networks has tried its best to ensure the accuracy and reliability of the content when compiling this manual, but it does not guarantee that the content of the manual is completely free of errors or omissions, and all the information in this manual does not constitute any explicit or implicit warranties.

Preface

Intended Audience

This document is intended for:

- Network engineers
- Technical support and servicing engineers
- Network administrators

Technical Support

- The official website of Ruijie Reyee: <https://reyye.ruijie.com>
- Technical Support Website: <https://reyye.ruijie.com/en-global/support>
- Case Portal: <https://www.ruijienetworks.com/support/caseportal>
- Community: <https://community.ruijienetworks.com>
- Technical Support Email: service_rj@ruijienetworks.com
- Online Robot/Live Chat: <https://reyye.ruijie.com/en-global/rita>

Conventions

1. GUI Symbols

Interface symbol	Description	Example
Boldface	1. Button names 2. Window names, tab name, field name and menu items 3. Link	1. Click OK . 2. Select Config Wizard . 3. Click the Download File link.
>	Multi-level menus items	Select System > Time .

2. Signs

This document also uses signs to indicate some important points during the operation. The meanings of these signs are as follows:

Warning

An alert that calls attention to important rules and information that if not understood or followed can result in data loss or equipment damage.

Note

An alert that calls attention to essential information that if not understood or followed can result in function failure or performance degradation.

 Instruction

An alert that contains additional or supplementary information that if not understood or followed will not lead to serious consequences.

 Specification

An alert that contains a description of product or version support.

3. Instruction

This manual is used to guide users to understand the product, install the product, and complete the configuration.

- The example of the port type may be different from the actual situation. Please proceed with configuration according to the port type supported by the product.
- The example of display information may contain the content of other product series (such as model and description). Please refer to the actual display information.
- The routers and router product icons involved in this manual represent common routers and layer-3 switches running routing protocols.

RG-RAP62-OD Access Point Implementation Cookbook

This cookbook consists of multiple independent volumes, introducing the installation, deployment, and web-based configuration of the RG-RAP62-OD access point, including:

01- Installation Guide

02- ReyeeOS 2.271 Configuration Guide

Ruijie Reyee RG-RAP62-OD Access Point

Installation Guide

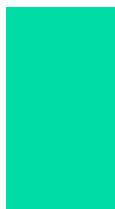
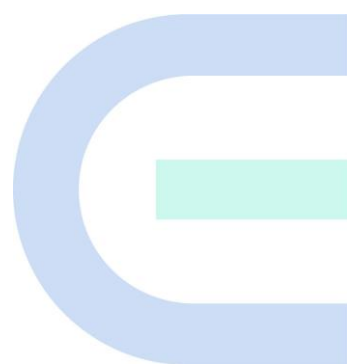

Copyright

Copyright © 2024 Ruijie Networks

All rights are reserved in this document and this statement.

Without the prior written consent of Ruijie Networks, any organization or individual shall not reproduce, extract, back up, modify, or propagate the content of this document in any manner or in any form, or translate it into other languages or use some or all parts of the document for commercial purposes.

 and other Ruijie networks logos are trademarks of Ruijie Networks.

All other trademarks or registered trademarks mentioned in this document are owned by their respective owners.

Disclaimer

The products, services, or features you purchase are subject to commercial contracts and terms, and some or all of the products, services, or features described in this document may not be available for you to purchase or use. Except for the agreement in the contract, Ruijie Networks makes no explicit or implicit statements or warranties with respect to the content of this document.

The names, links, descriptions, screenshots, and any other information regarding third-party software mentioned in this document are provided for your reference only. Ruijie Networks does not explicitly or implicitly endorse or recommend the use of any third-party software and does not make any assurances or guarantees concerning the applicability, security, or legality of such software. You should choose and use third-party software based on your business requirements and obtain proper authorization. Ruijie Networks assumes no liability for any risks or damages arising from your use of third-party software.

The content of this document will be updated from time to time due to product version upgrades or other reasons, Ruijie Networks reserves the right to modify the content of the document without any notice or prompt.

This manual is designed merely as a user guide. Ruijie Networks has tried its best to ensure the accuracy and reliability of the content when compiling this manual, but it does not guarantee that the content of the manual is completely free of errors or omissions, and all the information in this manual does not constitute any explicit or implicit warranties.

Preface

Audience

This document is intended for:

- Network engineers
- Technical support and servicing engineers
- Network administrators

Technical Support

- Official Website of Ruijie Reye: <https://reyee.ruijie.com>
- Technical Support Website: <https://reyee.ruijie.com/en-global/support>
- Case Portal: <https://www.ruijienetworks.com/support/caseportal>
- Community: <https://community.ruijienetworks.com>
- Technical Support Email: service_rj@ruijienetworks.com
- Online Robot/Live Chat: <https://reyee.ruijie.com/en-global/rita>

Conventions

1. GUI Symbols

Interface symbol	Description	Example
Boldface	1. Button names 2. Window names, tab name, field name and menu items 3. Link	1. Click OK . 2. Select Config Wizard . 3. Click the Download File link.
>	Multi-level menus items	Select System > Time .

2. Signs

The signs used in this document are described as follows:

 **Danger**
An alert that calls attention to safety instruction that if not understood or followed can result in personal injury.

 **Warning**
An alert that calls attention to important rules and information that if not understood or followed can result in data loss or equipment damage.

 **Caution**
An alert that calls attention to essential information that if not understood or followed can result in function failure or performance degradation.

 **Note**

An alert that contains additional or supplementary information that if not understood or followed will not lead to serious consequences.

 **Specification**

An alert that contains a description of product or version support.

3. Note

This manual provides installation steps, troubleshooting, technical specifications, and usage guidelines for cables and connectors. It is intended for users who want to understand the above and have extensive experience in network deployment and management, and assume that users are familiar with related terms and concepts.

Contents

Preface	1
1 Product Overview	1
1.1 About the RG-RAP62-OD	1
1.2 Package Contents	1
1.3 Product Appearance	2
1.3.1 Appearance	2
1.3.2 Port and Button	3
1.4 Technical Specifications	4
1.5 Power Supply Technical Specifications	6
1.6 Cooling	7
2 Preparing for Installation	8
2.1 Safety Precautions	8
2.1.1 General Safety Precautions	8
2.1.2 Handling Safety	8
2.1.3 Electrical Safety	8
2.2 Installation Environment Requirements	9
2.2.1 Bearing	9
2.2.2 Ventilation	9
2.2.3 Temperature and Humidity	9
2.2.4 EMI	9
2.3 Tools	10
3 Installing the AP	11
3.1 Installation Flowchart	11

3.2 Before You Begin.....	11
3.3 Safety Precautions During Installation	12
3.4 Installing the AP	12
3.4.1 Installing the AP	12
3.4.2 Mounting the AP on a Wall.....	13
3.4.3 Mounting the AP on a Pole	15
3.5 Bundling Cables.....	15
3.5.1 Precautions	15
3.5.2 Bundling Steps.....	15
3.6 Checklist After Installation	16
4 Debugging	17
4.1 Setting Up the Configuration Environment	17
4.2 Powering on the AP	17
4.2.1 Checklist Before Power-On	17
4.2.2 Checklist After Power-on	17
4.3 Logging in to the Web GUI	17
5 Monitoring and Maintenance.....	18
5.1 Monitoring	18
5.2 Maintenance	18
6 Troubleshooting.....	19
6.1 General Troubleshooting Flowchart	19
6.2 Common Faults.....	19
7 Appendixes.....	21
7.1 Connectors and Media.....	21

7.1.1 2500BASE-T/1000BASE-T/100BASE-TX	21
7.2 Cabling Recommendations.....	22

1 Product Overview

1.1 About the RG-RAP62-OD

The RG-RAP62-OD 3000M dual-band gigabit wireless access point (AP) is launched by Ruijie Reyee for Wi-Fi coverage. Supporting the IEEE 802.11 a/b/g/n/ac/ax protocols and the MIMO technology, this AP can operate in both 2.4 GHz and 5 GHz frequency bands, delivering a maximum data rate of 573 Mbps in the 2.4 GHz band and 2401 Mbps in the 5 GHz band. The RG-RAP62-OD features one 1 Gbps port supporting IEEE 802.3af/at-compliant PoE and 24 V passive PoE for power input.

The RG-RAP62-OD is designed with an IP65-rated casing, making it ideal for deployment in challenging environments. This effectively shields it from harsh weather and environmental conditions.

1.2 Package Contents

Table 1-1 Package Contents

No.	Item	Quantity
1	RG-RAP62-OD Access Point	1
2	Mounting Plate	1
3	Cable Tie (7.6 mm x 300 mm [0.30 in. x 11.81 in.])	2
5	Phillips Pan Head Screw (ST2.9 x 20 PA)	2
6	Wall Anchor (Diameter: 5 mm [0.20 in.], Length: 24 mm [0.94 in.])	2
7	User Manual	1
8	Warranty Card	1

 **Note**

The package contents generally contain the preceding items. The actual delivery is subject to the order contract. Please check your goods carefully against the order contract. If you have any questions, please contact the distributor.

1.3 Product Appearance

1.3.1 Appearance

Figure 1-1 Appearance



1.3.2 Port and Button

Figure 1-2 Port and Button

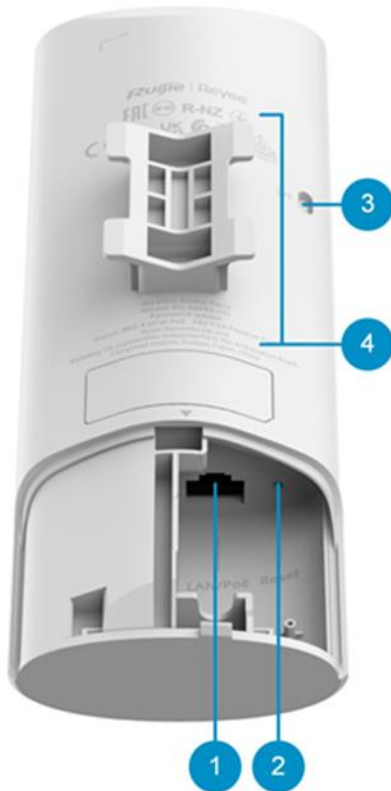

Table 1-2 Components on the Rear Panel

No.	Component	Description
1	LAN/PoE port	1 x 10/100/1000 BASE-T port with auto-negotiation, PoE-capable.
2	Reset button	<ul style="list-style-type: none"> ● Press and hold for less than 2 seconds: Restart the device. ● Press and hold for more than 5 seconds: Restore the device to factory settings.
4	Label	The label is located on the back of the device.

Table 1-3 LED

No.	Status	Description
3	Off	The device is not receiving power.
	Slow blinking blue	The device is operating but an alarm is generated.
	Fast blinking blue	Possible cases: <ul style="list-style-type: none"> ● The device is resetting. ● The device is upgrading.

No.	Status	Description
		<ul style="list-style-type: none"> ● The device is recovering. ● The device is starting up. Note: Do not power off the device when the LED is in this state.
	Solid blue	The device is operating properly and no alarm is generated.

1.4 Technical Specifications

Table 1-4 Specifications

Radio Design	Dual-band, dual-stream
Wi-Fi Standards	IEEE 802.11ax, IEEE 802.11ac Wave 1 and Wave 2, and IEEE 802.11a/b/g/n
Operating Frequency Bands	IEEE 802.11b/g/n/ax: 2.4 GHz to 2.4835 GHz IEEE 802.11a/n/ac/ax: 5.150 GHz to 5.350 GHz, 5.470 GHz to 5.7250 GHz, 5.725 GHz to 5.850 GHz
Antenna Type	Built-in directional antenna (2.4 GHz: Ant1: 3.0 dBi, Ant2: 4.0 dBi; 5 GHz: Ant1: 6.3 dBi, Ant2: 6.1 dBi, Ant3: 6.5 dBi)
Beam Angle	Omni-directional
Spatial Streams	2.4 GHz: 2 x 2 MIMO 5 GHz: 2 x 2 MIMO
Max. Wi-Fi Speed	2.4 GHz: 573 Mbps 5 GHz: 2401 Mbps Combined: 2974 Mbps
Modulation	OFDM: BPSK@6/9 Mbps, QPSK@12/18 Mbps, 16QAM@24 Mbps, 64QAM@48/54 Mbps DSSS: DBPSK@1 Mbps, DQPSK@2 Mbps, CCK@5.5/11 Mbps MIMO-OFDM: BPSK, QPSK, 16QAM, 64QAM, 256QAM, 1024QAM OFDMA
Receiver Sensitivity	11b: -96 dBm (1 Mbps), -93 dBm (5 Mbps), -89 dBm (11 Mbps) 11a/g: -91 dBm (6 Mbps), -85 dBm (24 Mbps), -80 dBm (36 Mbps), -74 dBm (54 Mbps) 11n: -90 dBm (MCS0), -70 dBm (MCS7), -89 dBm (MCS8), -68 dBm (MCS15) 11ac: 20 MHz: -88 dBm (MCS0), -63 dBm (MCS9) 11ac: 40 MHz: -85 dBm (MCS0), -60 dBm (MCS9) 11ac: 80 MHz: -85 dBm (MCS0), -60 dBm (MCS9)

	<p>11ax: 80 MHz: -82 dBm (MCS0), -57 dBm (MCS9), -52 dBm (MCS11)</p> <p>11ax: 160 MHz: -75 dBm (MCS0), -55 dBm (MCS9), -50 dBm (MCS11)</p>
Max. Transmit Power	<p>Frequency bands and maximum Effective Isotropic Radiated Power (EIRP):</p> <hr/> <p> Note</p> <p>Country-specific restrictions apply.</p> <hr/> <ul style="list-style-type: none"> ● European Union & United Kingdom: <ul style="list-style-type: none"> ○ 2400 MHz to 2483.5 MHz, EIRP ≤ 20 dBm ○ 5470 MHz to 5725 MHz, EIRP ≤ 30 dBm ● United States: <ul style="list-style-type: none"> ○ 2400 MHz to 2483.5 MHz, max output power ≤ 30 dBm & EIRP ≤ 36 dBm ○ 5150 MHz to 5250 MHz, max output power ≤ 30 dBm & EIRP ≤ 36 dBm ○ 5250 MHz to 5350 MHz, max output power ≤ 24 dBm & EIRP ≤ 30 dBm ○ 5470 MHz to 5725 MHz, max output power ≤ 24 dBm & EIRP ≤ 30 dBm ○ 5725 MHz to 5825 MHz, max output power ≤ 30 dBm & EIRP ≤ 36 dBm ● Myanmar: <ul style="list-style-type: none"> ○ 2400 MHz to 2483.5 MHz, EIRP ≤ 23 dBm ○ 5725 MHz to 5825 MHz, EIRP ≤ 30 dBm ● Thailand: <ul style="list-style-type: none"> ○ 2400 MHz to 2483.5 MHz, EIRP ≤ 20 dBm ○ 5470 MHz to 5725 MHz, EIRP ≤ 30 dBm ○ 5725 MHz to 5825 MHz, EIRP ≤ 30 dBm ● Indonesia: <ul style="list-style-type: none"> ○ 2400 MHz to 2483.5 MHz, EIRP ≤ 36 dBm ○ 5725 MHz to 5825 MHz, EIRP ≤ 36 dBm ● Egypt: <ul style="list-style-type: none"> ○ 2400 MHz to 2483.5 MHz, EIRP ≤ 20 dBm ○ 5150 MHz to 5350 MHz, EIRP ≤ 23 dBm
Power Step	1 dBm
Dimensions (W x D x H)	200 mm x 70 mm x 35 mm (7.87 in. x 2.76 in. x 1.38 in.) (excluding the mounting plate)
Weight	< 0.4 kg (0.88 lbs.) (excluding the mounting plate)
Service Ports	1 x 10/100/1000BASE-T port with auto-negotiation, PoE-capable
Management Port	N/A
Status LED	1 x system LED (blue)
Power Supply Mode	<ul style="list-style-type: none"> ● Standard PoE power supply: IEEE 802.3at (PoE+) (normal operation) ● Compatible with IEEE 802.3af (PoE) power supply (the third antenna on the 5 GHz radio is disabled) ● Passive 24 V 1 A adapter (normal operation) <p>For details, see Table 1-5 Relationship Between Power Supply Mode, Data Rate, and Power Input.</p>

Power Supply	<ul style="list-style-type: none"> ● IEEE 802.3af/at-compliant PoE power supply ● Passive PoE power supply: 24 V = 1 A
Max. Power Consumption	< 16 W
Bluetooth	Not supported
Environment	Operating temperature: -30°C to +65°C (-22°F to +149°F)
	Storage temperature: -40°C to +75°C (-40°F to +167°F)
	Operating humidity: 5% to 95% RH (non-condensing)
	Storage humidity: 5% to 95% RH (non-condensing)
Mounting	Wall-mount and pole-mount Note: The recommended mounting height ranges from 2.5 m (8.20 ft) to 3 m (9.84 ft).
Surge Protection	4 kV
Certification	CE, FCC, ISED, cTUVus
MTBF	> 400000 hrs

1.5 Power Supply Technical Specifications

The RG-RAP62-OD access point supports PoE power supply.

- When standard PoE power supply is used, ensure that the power source equipment (PSE) is at least IEEE 802.3at-compatible. You are advised to use an IEEE 802.3at-compliant PSE in order to optimize the device performance.
- When a 24 V passive PoE adapter is used for power supply, ensure that the adapter supplies an output voltage of 24 V and a maximum output current of 1 A. Use a Ruijie-certified PoE adapter.

The following table lists the relationship between the power supply mode, data rate, and power input.

Table 1-5 Relationship Between Power Supply Mode, Data Rate, and Power Input

Power input	Standard PoE power supply: <ul style="list-style-type: none"> ● IEEE 802.3at-compliant power supply ● IEEE 802.3af-compatible power supply (the third antenna on the 5 GHz radio is disabled) 24 V passive PoE adapter: 24 V = 1A			
Power supply mode	2.4 GHz	5 GHz	Combined rate	Power consumption
IEEE 802.3at-compliant power supply (recommended)	2 x 2	3 x 3	2976 Mbps	≤ 16 W
24 V/1 A passive PoE adapter	2 x 2	3 x 3	2976 Mbps	≤ 16 W

IEEE 802.3af-compatible power supply	2 x 2	2 x 2	2976 mbps (Wi-Fi performance and coverage degrade.)	≤ 13.5 W
--------------------------------------	-------	-------	--	---------------

1.6 Cooling

The RG-RAP62-OD access point adopts a fanless design. Therefore, a sufficient clearance must be maintained around the device for cooling.

2 Preparing for Installation

2.1 Safety Precautions

Note

- To prevent device damage and physical injury, please read the safety precautions carefully in this chapter.
 - The following safety precautions do not cover all possible hazardous situations.
-

2.1.1 General Safety Precautions

- Do not expose the AP to high temperature, dusts, or harmful gases.
 - Do not install the AP in an inflammable or explosive environment.
 - Keep the AP away from Electro-Magnetic Interference (EMI) sources such as large radar stations, radio stations, and substations.
 - Do not subject the AP to unstable voltage, vibration, and noises.
 - The installation site should be dry. Keep the AP at least 500 meters (1,640.41 ft.) away from the ocean and do not face it towards the sea breeze.
 - The installation site should be free from water, including possible flooding, seepage, dripping, or condensation. The installation site should be selected according to network planning and communications equipment features, and considerations such as climate, hydrology, geology, earthquake, electrical power, and transportation.
 - Ensure that the AP and the power distribution system are properly grounded.
-

Caution

Follow the installation instructions in the user manual to correctly install or remove the AP.

2.1.2 Handling Safety

- Avoid handling the AP frequently.
- Turn off all power supplies and unplug all power cables before you handle the AP.

2.1.3 Electrical Safety

Warning

- Improper or incorrect electrical operation can cause an accident such as fire or electric shock, thus causing severe even fatal damages to humans and devices.
 - Direct or indirect contact with a wet object (or your finger) on the high voltage and power line can be fatal.
-
- Observe local regulations and specifications when performing electrical operations. Relevant operators must be qualified.
 - Carefully check for any potential hazards in the working area such as damp/wet ground or floors.

- Find the location of the emergency power supply switch in the room before installation. Cut off the power supply first in case of an accident.
- Be sure to make a careful check before shutting down the power supply.
- Keep the AP far away from grounding or lightning protection devices for power equipment.
- Keep the AP away from radio stations, radar stations, high-frequency high-current devices, and microwave ovens.

2.2 Installation Environment Requirements

For normal operation and prolonged service life of the access point, the installation site must meet the following requirements.

2.2.1 Bearing

Evaluate the weight of the device and its accessories, and ensure that the installation site (such as the wall or pole) can bear the weight.

2.2.2 Ventilation

The AP adopts natural cooling. Reserve a sufficient clearance around the AP to ensure proper ventilation.

2.2.3 Temperature and Humidity

To ensure the normal operation and service life of the AP, maintain appropriate temperature and humidity in the equipment room. Improper room temperature and humidity can cause damage to the AP.

- High relative humidity may affect insulation materials, resulting in poor insulation and even electrical leakage. Sometimes it may lead to changes in the mechanical properties of materials and corrosion of metal parts.
- Low relative humidity can dry and shrink insulation sheets and cause static electricity that can damage the circuitry.
- High temperatures greatly reduce device reliability and shorten service life.

Table 2-1 Temperature and Humidity Requirements

Temperature	Humidity
-30°C to +65°C (-22°F to +149°F)	0% to 100% RH (non-condensing)

2.2.4 EMI

- Keep the AP as far away from the grounding equipment of the power device and the lightning prevention equipment as possible.
- Keep the AP away from radio stations, radar stations, high-frequency high-current devices, and microwave ovens.

2.3 Tools

Table 2-2 Tools

Common Tools	Phillips screwdriver, hex wrench, cables, Ethernet cable, cage nut, diagonal plier, cable ties
Special Tools	ESD gloves, wire stripper, crimping plier, RJ45 crimping plier, wire cutter, and waterproof adhesive tape
Meters	Multimeter
Relevant Devices	PC, display, and keyboard

 **Note**

The RG-RAP62-OD is delivered without a tool kit. The tool kit is customer-supplied.

3 Installing the AP

Caution

Before installing the AP, make sure that you have carefully read the requirements described in Chapter 2.

3.1 Installation Flowchart

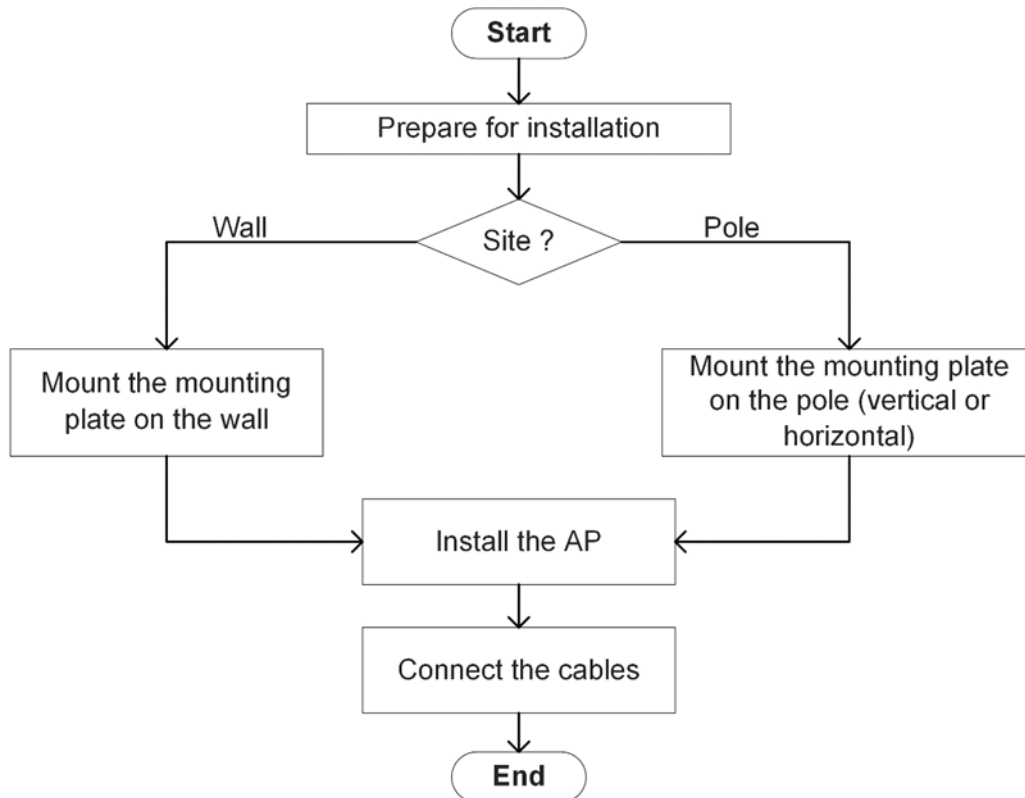

3.2 Before You Begin

Carefully plan and arrange the installation position, networking mode, power supply, and cabling before installation. Confirm the following requirements before installation:

- The installation site provides sufficient space for proper ventilation.
- The installation site meets the temperature and humidity requirements of the AP.
- The power supply and required current are available in the installation site.
- The selected power supply modules meet the system power requirements.
- The installation site meets the cabling requirements of the AP.
- The installation site meets the site requirements of the AP.
- The customized AP meets the client-specific requirements.

3.3 Safety Precautions During Installation

This AP can be mounted on a wall or a pole with a diameter ranging from 40 mm to 70 mm (1.57 in. to 2.76 in.). If the diameter of the pole is out of this range, please prepare a hose clamp that can hold the pole. The thickness of the hose clamp should be at least 2.5 mm (0.10 in.). The installation site is determined by the technical personnel after a site survey.

Please make sure that the installation site meets the requirements in [2.2 Installation Environment Requirements](#), and observe the following precautions:

- Do not power on the AP during installation.
- Install the AP in a well-ventilated location.
- Do not expose the AP to high temperature.
- Keep the AP away from high-voltage power cables.
- Do not expose the AP to a thunderstorm or strong electric field.
- Cut off the power supply before cleaning the AP.
- Do not open the enclosure when the AP is working.
- Secure the AP tightly.

3.4 Installing the AP

⚠ Caution

- Install the AP in a manner that maximizes the coverage area of the antenna.
 - The schematic diagram provided is for reference purposes only. The actual product should be installed based on its physical specifications and design.
-

3.4.1 Installing the AP

- (1) Remove the rear cover of the RG-RAP62-OD AP.

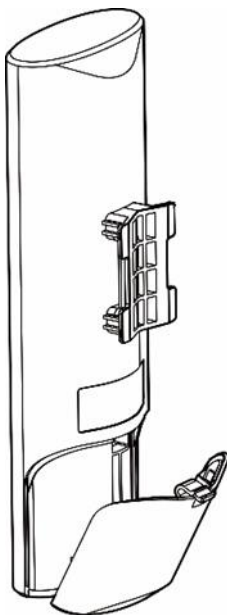

- (2) Insert the Ethernet cable into the LAN/PoE port of the AP.

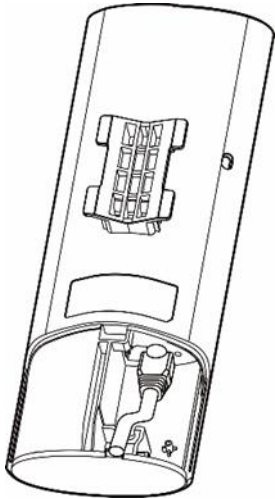

- (3) Install the rear cover.

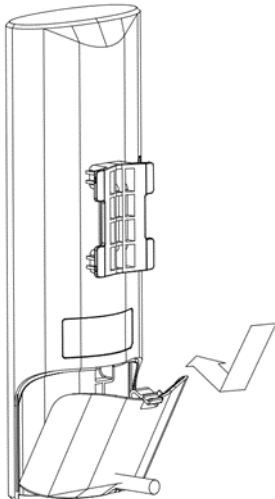

3.4.2 Mounting the AP on a Wall

Use the supplied mounting plate, wall anchors, and Philips pan head screws to mount the AP on a wall.

- (1) Drill two screw holes on the wall, with a distance of 54 ± 0.5 mm (2.13 ± 0.02 in.). Then, insert a wall anchor into each screw hole.

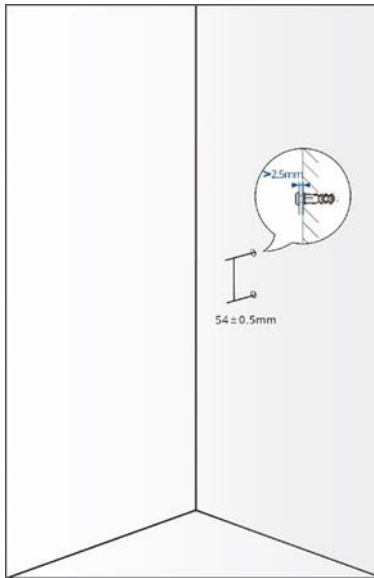

- (2) Fix the mounting plate to the wall (pay attention to the orientation of the mounting plate). After adjusting the installation position, use two Philips pan head screws to secure the mounting plate to the wall.

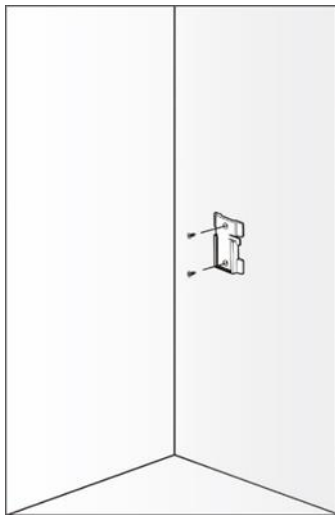

- (3) Align the slots on the back of the AP with the square feet on the mounting plate, and slide the AP into the mounting plate slowly to ensure that the AP is securely fixed.

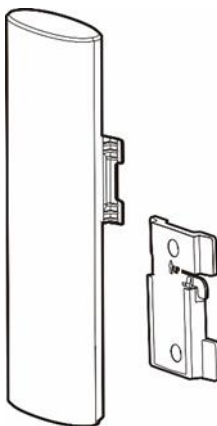

3.4.3 Mounting the AP on a Pole

- (1) Take out two cable ties and thread them through the square holes on the back of the AP.

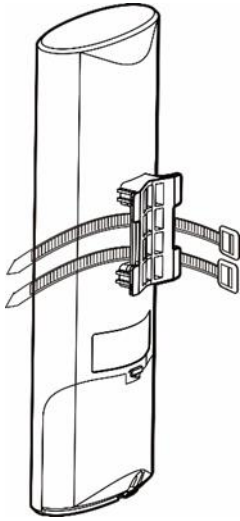

- (2) Press the AP against on the pole, and tighten the cable ties.

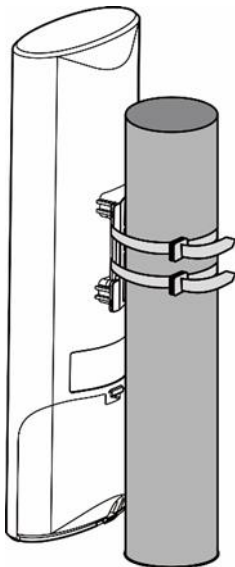

3.5 Bundling Cables

3.5.1 Precautions

- The power cord and other cables should be neatly bundled.
- Make sure that the fibers at the connectors have natural bends or bends of large radius.
- Do not bind fibers and twisted pair cables too tightly, as this may press the fibers and affect their service life and transmission performance.

3.5.2 Bundling Steps

- (1) Bundle the drooping part of the cables and place the bundle as near the ports as possible.

- (2) Secure the cables in the cable management trough of the mounting plate.
- (3) Route the cables under the AP and run them in straight line.

3.6 Checklist After Installation

- (1) Checking the AP
 - Verify that the external power supply matches with the requirement of the AP.
 - Verify that the AP is securely fastened.
- (2) Checking Cable Connections
 - Verify that the UTP/STP cable matches with the port type.
 - Verify that the cables are properly bundled.
- (3) Checking Power Supply
 - Verify that the power cord is properly connected and meets safety requirements.
 - Verify that the AP works properly when powered by the power supply.

4 Debugging

4.1 Setting Up the Configuration Environment

Power on the AP using a standard PoE or 24 V passive PoE adapter.

- Verify that the power cord is properly connected and compliant with safety requirements.
- Connect the AP to the PC using an Ethernet cable.

4.2 Powering on the AP

4.2.1 Checklist Before Power-On

- The AP is properly grounded.
- The power cord is properly connected.
- The input voltage meets the requirement.

4.2.2 Checklist After Power-on

- Verify that there is system log printed on the terminal interface.
- Verify the LED status.

4.3 Logging in to the Web GUI

- (1) Power on the PC and configure the local connection attribute on the PC. Set the IP address of the PC to 10.44.77.XXX (1 to 255, excluding 254).

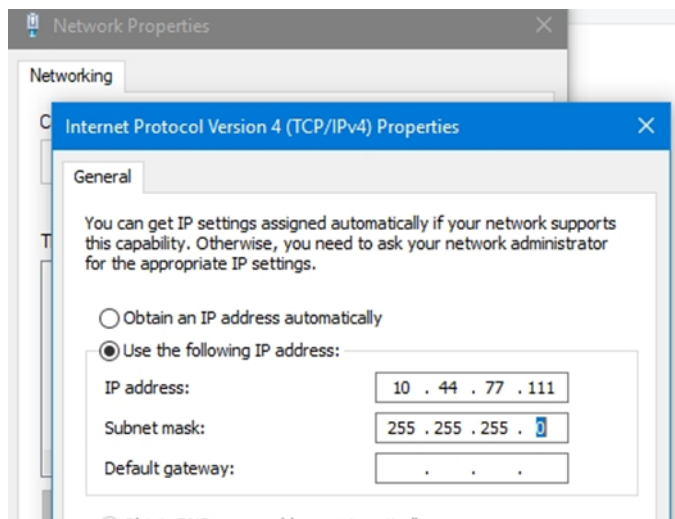

- (2) Open a browser on the PC and enter 10.44.77.254 to log in to the web interface. The default password is admin for the first login. For security purposes, change the default password after login.

5 Monitoring and Maintenance

5.1 Monitoring

When RG-RAP62-OD is operating, you can monitor its status by observing the LEDs.

5.2 Maintenance

If the hardware is faulty, please contact the local distributor.

6 Troubleshooting

6.1 General Troubleshooting Flowchart

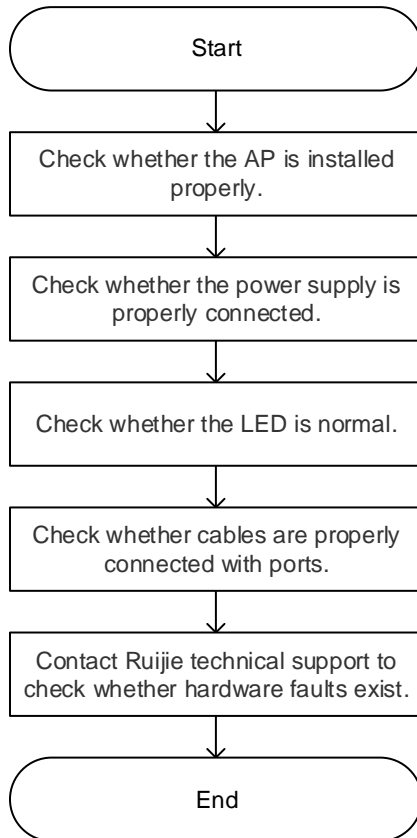

6.2 Common Faults

- The status LED is off after the AP is powered on.
 - If the AP is powered by a standard PoE power source, verify that the PSE is IEEE 802.3af-compliant and that the Ethernet cable is properly connected.
 - If the AP is powered by a 24 V passive PoE adapter, verify that the power output specifications of the adapter are 24 V/1 A.
- The Ethernet port does not work after the Ethernet cable is connected.

Verify that the device at the other end of the Ethernet cable is working properly. Then, verify that the cable is capable of providing the required data rate and is properly connected.
- A client cannot discover the AP.
 - Verify that the AP is properly powered.
 - Verify that the Ethernet port is correctly connected.
 - Verify that the AP is correctly configured.

- Move the client device closer to the AP.

7 Appendixes

7.1 Connectors and Media

7.1.1 2500BASE-T/1000BASE-T/100BASE-TX

The 2500BASE-T/1000BASE-T/100BASE-TX port is a 100/1000/2500 Mbps port that supports auto MDI/MDIX Crossover.

Compliant with the IEEE 802.3bz standard, 2500BASE-T requires a Category 6 (Cat 6) or Category 5e (Cat 5e) 100-ohm UTP or STP (recommended) cable with a maximum distance of 100 meters (328 feet). When PoE power supply is used at the same time, a CAT6 STP cable is recommended, and both the port and cable should be properly shielded.

Compliant with the IEEE 802.3ab standard, 1000BASE-T port requires a Cat 6 or Cat 5e 100-ohm UTP or STP (recommended) cable with a maximum distance of 100 meters (328 feet). When PoE power supply is used at the same time, a CAT6 STP cable is recommended, and both the port and cable should be properly shielded.

The 2500BASE-T/1000BASE-T port requires four pairs of wires to be connected for data transmission. Figure 7-1 shows the four pairs of wires for the 2500BASE-T/1000BASE-T port.

Figure 7-1 2500BASE-T/1000BASE-T Twisted Pair Connections

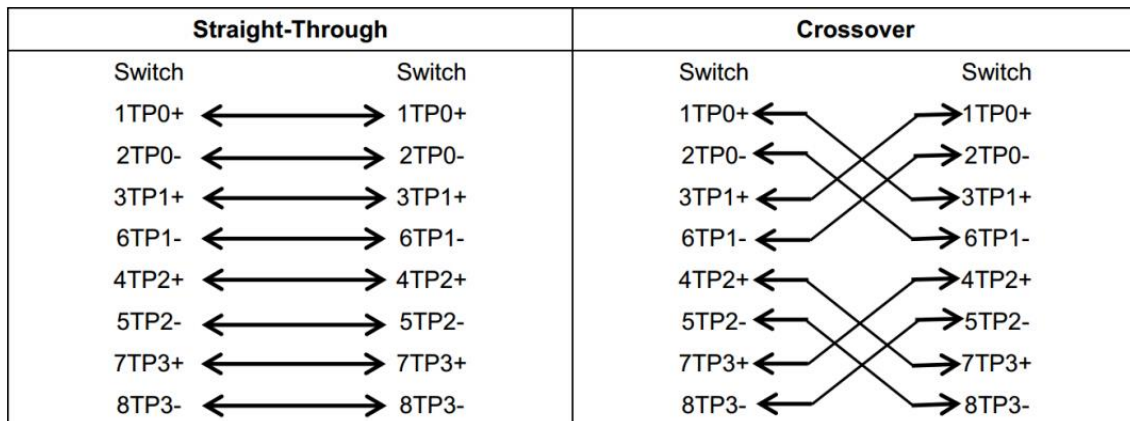

The 100BASE-TX port can be connected using 100-ohm Category 5 (Cat 5) cables with a maximum distance of 100 meters (328 ft.). Table 7-1 shows 100BASE-TX pin assignments.

Table 7-1 100BASE-TX Pin Assignments

Pin	Socket	Plug
1	Input Receive Data+	Output Transmit Data+
2	Input Receive Data-	Output Transmit Data-
3	Output Transmit Data+	Input Receive Data+
6	Output Transmit Data-	Input Receive Data-

Pin	Socket	Plug
4, 5, 7, 8	Not Used	Not Used

Figure 7-2 show feasible connections of the straight-through and crossover twisted pairs for a 100BASE-TX port.

Figure 7-2 100BASE-TX Twisted Pair Connection

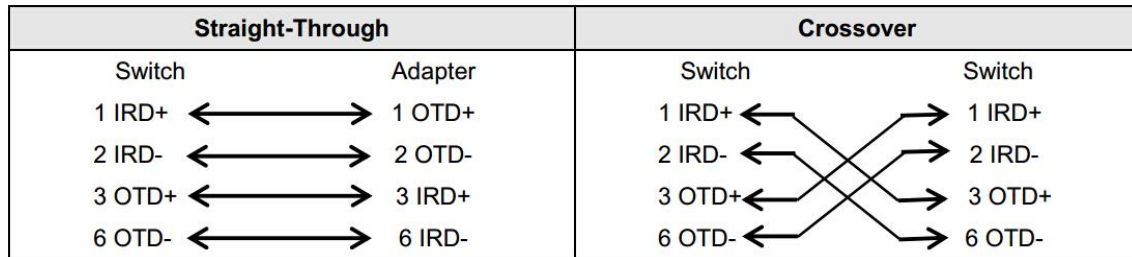

7.2 Cabling Recommendations

During installation, route cable bundles upward or downward along the sides of the rack depending on the actual situation in the equipment room. All cable connectors used for transit should be placed at the bottom of the cabinet rather than be exposed outside of the cabinet. Power cords are routed beside the cabinet, and top cabling or bottom cabling is adopted according to the actual situation in the equipment room, such as the positions of the DC power distribution box, AC socket, or lightning protection box.

Requirements for Cable Bend Radius

- The bend radius of a fixed power cord, network cable, or flat cable should be over five times greater than their respective diameters. The bend radius of these cables that are often bent or plugged should be over seven times greater than their respective diameters.
- The bend radius of a fixed common coaxial cable should be over seven times greater than its diameter. The bend radius of the common coaxial cable that is often bent or plugged should be over 10 times greater than its diameter.
- The bend radius of a fixed high-speed cable (such as an SFP+ cable) should be over five times greater than its diameter. The bend radius of the fixed high-speed cable that is often bent or plugged should be over 10 times greater than its diameter.

Precautions for Bundling up Cables

- Before cables are bundled, mark labels and stick the labels to cables wherever appropriate.
- Cables should be neatly and properly bundled in the rack without twisting or bending, as shown in Figure 7-3.

Figure 7-3 Bundling up Cables (1)

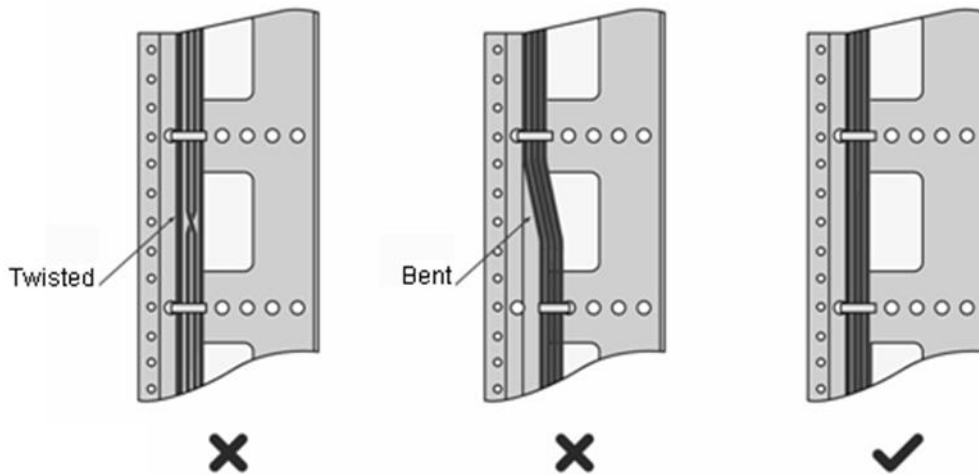

- Cables of different types (such as power cords, signal cables, and grounding cables) should be separated in cabling and bundling. Mixed bundling is disallowed. When they are close to each other, you are advised to adopt crossover cabling. In the case of parallel cabling, maintain a minimum distance of 30 mm (1.18 in.) between power cords and signal cables.
- The cable management brackets and cabling troughs inside and outside the cabinet should be smooth without sharp corners.
- The metal hole traversed by cables should have a smooth and fully rounding surface or an insulated lining.
- Use cable ties to bundle up cables properly. Do not connect two or more cable ties to bundle up cables.
- After bundling up cables with cable ties, cut off the remaining part. The cut should be smooth and trim, without sharp corners, as shown in Figure 7-4.

Figure 7-4 Bundling up Cables (2)

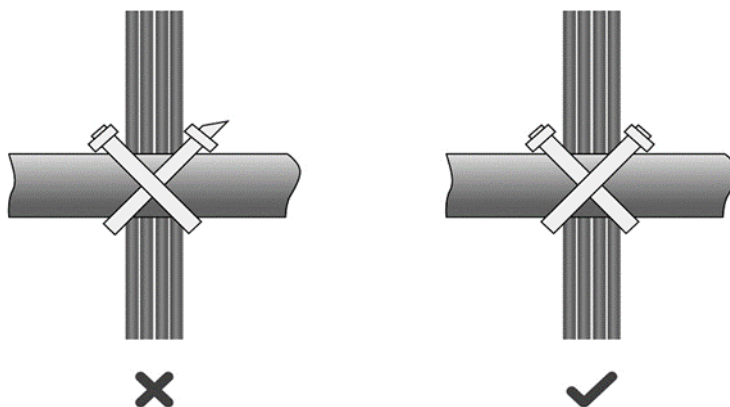

- When cables need to be bent, you should first bundle them up, as shown in Figure 7-5. However, the buckle cannot be bundled within the bend area. Otherwise, considerable stress may be generated in cables, breaking cable cores.

Figure 7-5 Bundling up Cables (3)

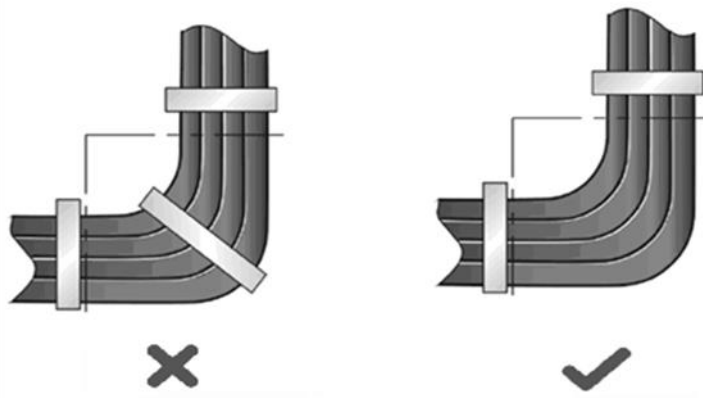

- Cables not to be assembled or remaining parts of cables should be folded and placed in a proper position of the rack or cable trough. The proper position refers to a position that does not affect device running or damage the device or cable.
- 220 V and -48 V power cords must not be bundled on the guide rails of moving parts.
- The power cords connecting moving parts such as grounding cables should be reserved with some access after being assembled to avoid suffering tension or stress. After the moving part is installed, the remaining cable part should not touch heat sources, sharp corners, or sharp edges. If heat sources cannot be avoided, high-temperature cables should be used.
- When screw threads are used to fasten cable terminals, the anchor or screw must be tightly fastened, as shown in Figure 7-6.

Figure 7-6 Cable Fastening

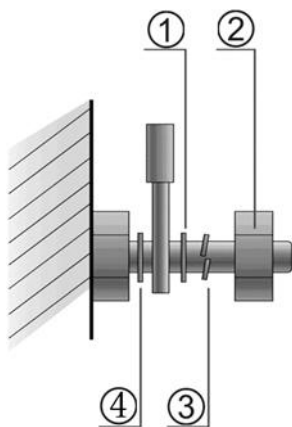

① Flat Washer	③ Spring Washer
② Nut	④ Flat Washer

- Hard power cords should be fastened in the terminal connection area to prevent stress on terminal connection and cable.
- Do not use self-tapping screws to fasten terminals.

- Power cords of the same type and in the same cabling direction should be bundled up into cable bunches, with cables in cable bunches clean and straight.
- Binding by using buckles should be performed according to Table 7-2.

Table 7-2 Cable Bunch

Cable Bunch Diameter	Distance between Every Binding Point
10 mm (0.39 in.)	80 mm to 150 mm (3.15 in. to 5.91 in.)
10 mm to 30 mm (0.39 in. to 1.18 in.)	150 mm to 200 mm (5.91 in. to 7.87 in.)
30 mm (1.18 in.)	200 mm to 300 mm (7.87 in. to 11.81 in.)

- No knot is allowed in cabling or bundling.
- For wiring terminal blocks (such as air switches) of the cord end terminal type, the metal part of the cord end terminal should not be exposed outside the terminal block when assembled.

Ruijie Reyee RG-RAP62-OD Access Point

ReyeeOS 2.271 Configuration Guide

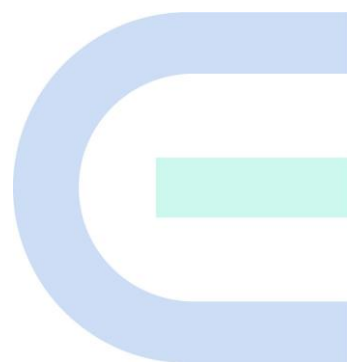

Copyright

Copyright © 2024 Ruijie Networks

All rights are reserved in this document and this statement.

Without the prior written consent of Ruijie Networks, any organization or individual shall not reproduce, extract, back up, modify, or propagate the content of this document in any manner or in any form, or translate it into other languages or use some or all parts of the document for commercial purposes.



and other Ruijie networks logos are trademarks of Ruijie Networks.

All other trademarks or registered trademarks mentioned in this document are owned by their respective owners.

All other trademarks or registered trademarks mentioned in this document are owned by their respective owners.

Disclaimer

The products, services, or features you purchase are subject to commercial contracts and terms, and some or all of the products, services, or features described in this document may not be available for you to purchase or use. Except for the agreement in the contract, Ruijie Networks makes no explicit or implicit statements or warranties with respect to the content of this document.

The names, links, descriptions, screenshots, and any other information regarding third-party software mentioned in this document are provided for your reference only. Ruijie Networks does not explicitly or implicitly endorse or recommend the use of any third-party software and does not make any assurances or guarantees concerning the applicability, security, or legality of such software. You should choose and use third-party software based on your business requirements and obtain proper authorization. Ruijie Networks assumes no liability for any risks or damages arising from your use of third-party software.

The content of this document will be updated from time to time due to product version upgrades or other reasons, Ruijie Networks reserves the right to modify the content of the document without any notice or prompt.

This manual is designed merely as a user guide. Ruijie Networks has tried its best to ensure the accuracy and reliability of the content when compiling this manual, but it does not guarantee that the content of the manual is completely free of errors or omissions, and all the information in this manual does not constitute any explicit or implicit warranties.

Preface

Audience

This document is intended for:

- Network engineers
- Technical support and servicing engineers
- Network administrators

Technical Support

- Official Website of Ruijie Reyee: <https://www.ruijienetworks.com/products/reyee>
- Technical Support Website: <https://ruijienetworks.com/support>
- Case Portal: <https://www.ruijienetworks.com/support/caseportal>
- Community: <https://community.ruijienetworks.com>
- Technical Support Email: service_rj@ruijienetworks.com
- Online Robot/Live Chat: <https://ruijienetworks.com/rita>

Conventions

1. GUI Symbols

Interface symbol	Description	Example
Boldface	1. Button names 2. Window names, tab name, field name and menu items 3. Link	1. Click OK . 2. Select Config Wizard . 3. Click the Download File link.
>	Multi-level menu items	Select System > Time .

2. Signs

The signs used in this document are described as follows:

Warning

An alert that calls attention to important rules and information that if not understood or followed can result in data loss or equipment damage.

Caution

An alert that calls attention to essential information that if not understood or followed can result in function failure or performance degradation.

 Note

An alert that contains additional or supplementary information that if not understood or followed will not lead to serious consequences.

 Specification

An alert that contains a description of product or version support.

3. Note

This manual introduces the features of the product and offers guidance on configuration and testing.

Contents

Preface	1
1 Fast Internet Access.....	1
1.1 Configuration Environment Requirements	1
1.1.1 PC	1
1.2 Default Configuration	1
1.3 Login to Web Interface.....	1
1.3.1 Connecting to the Access Point.....	1
1.3.2 Configuring the IP Address of the Management Client	2
1.3.3 Logging in to the Web Page	2
1.4 Work Mode.....	3
1.4.1 AP Mode.....	3
1.4.2 Router Mode	3
1.4.3 Wireless Repeater Mode	4
1.5 Configuration Wizard (Router Mode).....	4
1.5.1 Getting Started.....	4
1.5.2 Configuration Steps	5
1.6 Configuration Wizard (AP Mode).....	8
1.6.1 Getting Started.....	8
1.6.2 Configuration Steps	8
1.7 Configuration Wizard (Wireless Repeater Mode).....	9
1.7.1 Getting Started.....	9
1.7.2 Configuration Steps	9
1.8 Introduction to the Web Interface	12

1.8.1 Management Page for Wi-Fi 6 Products and Above	12
2 Network Monitoring	1
2.1 Viewing the Network Information	1
2.2 Adding Network Devices	3
2.2.1 Wired Connection	3
2.2.2 AP Mesh	4
2.3 Managing Network Devices	13
2.4 Configuring Network Planning	14
2.4.1 Configuring Wired VLAN	16
2.4.2 Configuring Wi-Fi VLAN	18
3 Wi-Fi Network Settings	21
3.1 Configuring AP Groups	21
3.1.1 Overview	21
3.1.2 Configuration Steps	21
3.2 Adding a Wi-Fi Network	23
3.3 Configuring SSID and Wi-Fi Password	26
3.4 Hiding the SSID	27
3.4.1 Overview	27
3.4.2 Configuration Steps	27
3.5 Checking Wireless Clients	28
3.6 Configuring Wi-Fi Band	29
3.7 Configuring Band Steering	30
3.8 Configuring Wi-Fi 6	31
3.9 Configuring Wi-Fi 7	32

3.10 Configuring Layer-3 Roaming.....	32
3.11 Configuring Client Isolation.....	33
3.12 Configuring 802.11r	34
3.13 Configuring a Guest Wi-Fi	34
3.13.1 Overview	34
3.13.2 Configuration Steps	34
3.14 Configuring Wireless Rate Limiting	35
3.14.1 Overview	35
3.14.2 Configuration Steps	35
3.15 Configuring Wi-Fi Blocklist or Allowlist	39
3.15.1 Overview	39
3.15.2 Configuration Steps	39
3.16 Optimizing Wi-Fi Network	41
3.16.1 Overview	41
3.16.2 Getting Started.....	41
3.16.3 Optimizing the Radio Channel.....	42
3.16.4 Optimizing the Channel Width	43
3.16.5 Optimizing the Transmit Power.....	44
3.16.6 Configuring the Multicast Rate.....	44
3.16.7 Configuring the Client Limit.....	45
3.16.8 Configuring the Kick-off Threshold	46
3.16.9 Configuring the Roaming Sensitivity.....	46
3.16.10 Configuring Access Threshold.....	47
3.16.11 Configuring Response RSSI Threshold.....	47

3.16.12 Configuring WIO	48
3.16.13 Configuring Wi-Fi Roaming Optimization (802.11k/v)	52
3.17 Configuring IGMP Snooping	53
3.17.1 Overview	53
3.17.2 Configuration Steps	54
3.18 Configuring Healthy Mode	54
3.19 Configuring XPress	55
3.20 Configuring Wireless Schedule	55
3.21 Enabling Reye Mesh.....	56
3.22 Domain Proxy	56
3.23 Client Association	57
3.24 Configuring AP Load Balancing.....	58
3.24.1 Overview	58
3.24.2 Configuring Client Load Balancing	59
3.24.3 Configuring Traffic Load Balancing.....	61
3.25 Wireless Authentication	62
3.25.1 Overview	62
3.25.2 Configuring One-click Login on Ruijie Cloud.....	63
3.25.3 Configuring Voucher Authentication on Ruijie Cloud.....	68
3.25.4 Configuring Account Authentication on Ruijie Cloud	76
3.25.5 Configuring SMS Authentication on Ruijie Cloud	84
3.25.6 Configuring Registration on Ruijie Cloud	91
3.25.7 Configuring an Authentication-Free User List on Web Interface.....	96
3.25.8 Displaying Authenticated Users on web interface	99

3.25.9 Displaying Authenticated Users on Ruijie Cloud	99
3.26 Configuring 802.1X Authentication	100
3.26.1 Overview	100
3.26.2 Configuring 802.1X Authentication	100
3.26.3 Viewing Wireless User List	105
3.26.4 Viewing Wired User List.....	105
4 Network Settings	106
4.1 Switching Work Mode	106
4.1.1 Work Mode.....	106
4.1.2 Self-Organizing Network Discovery	106
4.1.3 Configuration Steps	106
4.2 Configuring Internet Connection Type (IPv4)	108
4.3 Configuring Internet Connection Type (IPv6)	109
4.4 Configuring LAN Port.....	109
4.5 Configuring Repeater Mode.....	111
4.5.1 Wired Repeater	111
4.5.2 Wireless Repeater	111
4.6 Creating a VLAN.....	113
4.7 Configuring Port VLAN	115
4.8 Changing MAC Address	116
4.9 Changing MTU.....	117
4.10 Configuring DHCP Server.....	118
4.10.1 DHCP Server	118
4.10.2 Configuring the DHCP Server Function.....	118

4.10.3	Displaying Online DHCP Clients.....	119
4.10.4	Displaying the DHCP Static IP Address List.....	120
4.11	Configuring DNS.....	120
4.12	Configuring Self-Healing Mesh.....	121
4.13	Hardware Acceleration.....	121
4.14	Configuring Port Flow Control.....	121
4.15	Configuring ARP Binding.....	121
4.16	IPv6 Settings.....	122
4.16.1	Overview.....	122
4.16.2	IPv6 Basic.....	122
4.16.3	IPv6 Address Assignment Methods.....	123
4.16.4	Enabling IPv6.....	124
4.16.5	Configuring the IPv6 Address for the WAN Port.....	124
4.16.6	Configuring the IPv6 Address for the LAN Port.....	126
4.16.7	Viewing DHCPv6 Clients.....	128
4.16.8	Configuring the Static DHCPv6 Address.....	128
4.16.9	Configuring the IPv6 Neighbor List.....	129
5	Online Client Management.....	131
5.1	Configuring Client IP Binding.....	133
5.2	Configuring Client Association.....	134
5.3	Blocking Clients.....	135
5.4	Configuring Client Rate Limiting.....	136
6	System Settings.....	138
6.1	PoE Settings.....	138

6.2 Setting the Login Password	138
6.3 Setting the Session Timeout Duration	139
6.4 Setting and Displaying System Time	139
6.5 Configuring SNMP	140
6.5.1 Overview	140
6.5.2 Global Configuration	140
6.5.3 View/Group/Community/User Access Control	142
6.5.4 SNMP Service Typical Configuration Examples	150
6.5.5 Configuring Trap Service	155
6.5.6 Trap Service Typical Configuration Examples	159
6.6 Configuring Reboot	162
6.6.1 Rebooting the Master Device	162
6.6.2 Rebooting Local Device	163
6.6.3 Rebooting All Devices on the Network	163
6.6.4 Rebooting the Specified Devices	164
6.7 Configuring Scheduled Reboot	165
6.8 Configuring Backup and Import	166
6.9 Restoring Factory Settings	166
6.9.1 Restoring the Current Device to Factory Settings	166
6.9.2 Restoring All Devices to Factory Settings	167
6.9.3 Restoring Master Device to Factory Settings	167
6.10 Performing Upgrade and Checking System Version	168
6.10.1 Online Upgrade	168
6.10.2 Local Upgrade	169

6.11 Switching System Language	169
6.12 Configuring LED Status Control	169
6.13 Configuring Cloud Service	170
6.13.1 Overview	170
6.13.2 Configuration Steps	170
6.13.3 Unbinding Cloud Service	172
7 Network Diagnosis Tools	173
7.1 Network Check.....	173
7.2 Network Tools.....	174
7.3 Alerts	175
7.4 Fault Collection	176
7.5 Packet Capturing	176
8 FAQs.....	179
8.1 Login Failure	179
8.2 Factory Setting Restoration	179
8.3 Password Loss.....	179

1 Fast Internet Access

1.1 Configuration Environment Requirements

1.1.1 PC

- Browser: Google Chrome, Internet Explorer 9.0, 10.0, and 11.0, and some Chromium/Internet Explorer kernel-based browsers (such as 360 Extreme Explorer) are supported. Exceptions such as garble or format error may occur if an unsupported browser is used.
- Resolution: 1024 x 768 or a higher resolution is recommended. If other resolutions are used, the page fonts and formats may not be aligned, the GUI is less artistic, or other exceptions may occur.

1.2 Default Configuration

Table 1-1 Default Web Configuration

Item	Default
IP address	10.44.77.254
Username/Password	A username is not required when you log in for the first time. The default password is admin .

1.3 Login to Web Interface

1.3.1 Connecting to the Access Point

You can open the management page and complete Internet access configuration only after connecting a client to the access point in either of the following ways:

- Wired Connection

Connect a local area network (LAN) port of the access point to the network port of the PC, and set the IP address of the PC. See [Configuring the IP Address of the Management Client](#).

- Wireless Connection

On a mobile phone or laptop, search for wireless network **@Ruijie-SXXXX** (XXXX is the last four digits of the MAC address of each device). In this mode, you do not need to set the IP address of the management Client, and you can skip the operation in [Configuring the IP Address of the Management Client](#).

1.3.2 Configuring the IP Address of the Management Client

Configure an IP address for the management client in the same network segment as the default IP address of the device (The default device IP address is 10.44.77.254, and the subnet mask is 255.255.255.0.) so that the management client can access the device. For example, set the IP address of the management client to 10.44.77.100.

Caution

- Make sure that the client can access the web interface as long as it can ping the access point.
 - The IP address of the management client cannot be set to 10.44.77.253, because this IP address is reserved by the device. If the management client uses this IP address, it cannot access the device.
-

1.3.3 Logging in to the Web Page

- (1) Enter the IP address (10.44.77.254 by default) of the access point in the address bar of the browser to open the login page.

Note

If the static IP address of the device is changed, or the device obtains a new dynamic IP address, the new IP address can be used to access the web management system of the device as long as the management client and the device are in the same network segment of a LAN.

- (2) On the web page, enter the password and click **Log In** to enter the web management system.

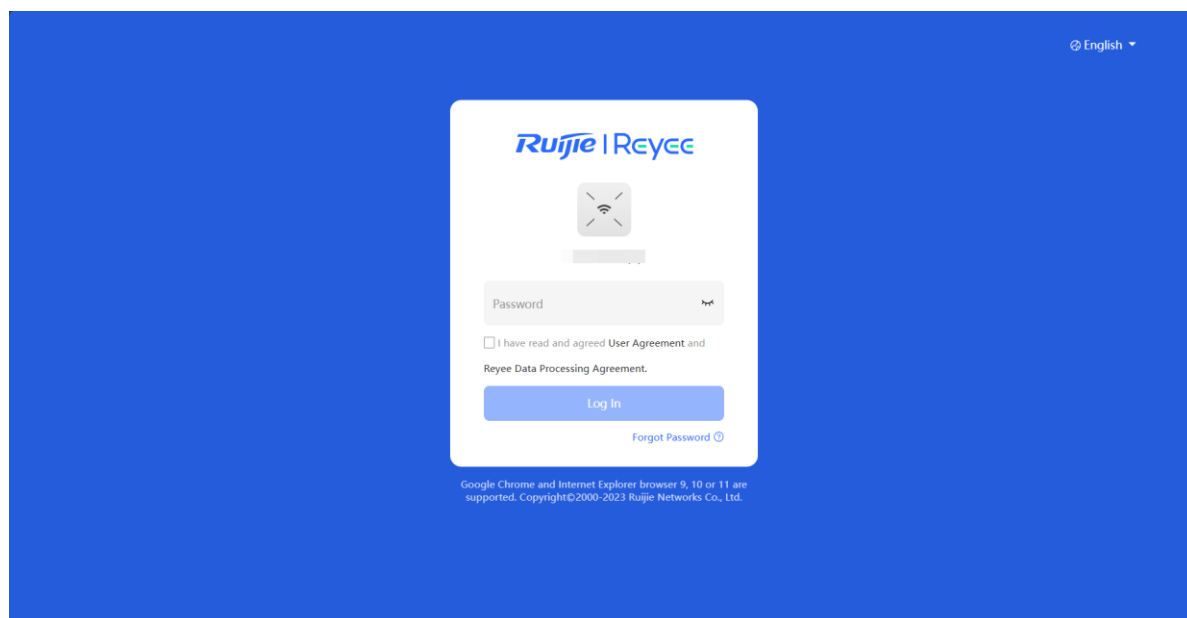

You can use the default password **admin** to log in to the device for the first time. For security purposes, you are advised to change the default password as soon as possible after logging in, and to regularly update your password thereafter.

If you forget the IP address or password, hold down the **Reset** button on the device panel for more than 5 seconds when the device is connected to the power supply to restore factory settings. After restoration, you can use the default IP address and password to log in.

 **Caution**

Restoring factory settings will delete the existing configuration and you are required to configure the device again at your next login. Therefore, exercise caution when performing this operation.

1.4 Work Mode

The device can work in the router mode, AP mode or wireless repeater mode. The displayed system menu page and function ranges vary with the work mode. The RAP works in the AP mode by default.

When setting the work mode, you can also set whether to enable the self-organizing network discovery function. This function is enabled by default.

Self-organizing network mode: After the self-organizing network discovery function is enabled, the new device and other unconnected devices can be discovered. Devices connect with each other to form a network based on their status and synchronize their configurations globally. You can log in to the web interface of the device to view management information of all devices on the network. After the self-organizing network discovery function is enabled, you can efficiently maintain and manage the network. You are advised to keep this function enabled.

When the device connect with each other to form a network, two configuration modes are displayed: network-wide mode and local device mode. See [1.8 Introduction to the Web I](#).

Local device mode: After the self-organizing network discovery function is disabled, the device will not be discovered. After logging in to the web interface, you can configure and manage only the new device. If only one device is configured or global configuration does not need to be synchronized to the device, you can disable the self-organizing network discovery function.

To switch the work mode, see [4.1 Switching Work Mode](#).

1.4.1 AP Mode

The device performs L2 forwarding and does not support the DHCP address pool function. In AP mode, the device often networks with devices supporting the routing function. IP addresses of downlink wireless clients are assigned and managed by the uplink device (supporting the DHCP address pool) of the AP in a unified manner, and the AP only transparently transmits data.

1.4.2 Router Mode

The device supports N/AT routing and forwarding. The addresses of wireless clients can be assigned by the AP and wireless network data is routed and forwarded by the AP. N/AT is supported in this mode. When an AP works in the router mode, it supports device networking, network-wide configuration, and AP-specific radio functions.

There are three Internet types available: PPPoE, DHCP mode and static IP address mode. You can connect the device to an Ethernet cable or an upstream device.

⚠ Caution

After switching to the router mode, the device's LAN IP address will change to 192.168.120.1. Please obtain an IP address automatically for your management client and enter 10.44.77.254 into the address bar of the browser to log in to web interface again.

1.4.3 Wireless Repeater Mode

The device does not support the routing and DHCP server functions in the wireless repeater mode. IP addresses of the clients are assigned and managed by the primary router. On an available network, the device can be connected to the primary router through wireless connection to expand the Wi-Fi coverage and increase the number of LAN ports and wireless access devices.

1.5 Configuration Wizard (Router Mode)

Upon first login, you can perform quick setup to configure the Internet type, Wi-Fi network and management password.

1.5.1 Getting Started

- (1) Connect the device to a power supply and connect the port of the device to an upstream device with an Ethernet cable. Or you can connect an Ethernet cable to the device.
- (2) Configure the Internet connection type according to requirements of the local Internet Service Provider (ISP). Otherwise, the Internet access may fail due to improper configuration. You are advised to contact your local ISP to confirm the Internet connection type:
 - Figure out whether the Internet connection type is PPPoE, DHCP mode, or static IP address mode.
 - In the PPPoE mode, a username, a password, and possibly a service name are needed.
 - In the static IP address mode, an IP address, a subnet mask, a gateway, and a DNS server need to be configured.
- (3) The device works in the AP mode by default. If you want to switch the work mode to the router mode, perform the configuration on the work mode setting page. See [4.1 Switching Work Mode](#) for more details.

The dashboard displays the following information:

- AP Status:** Working Mode: AP (highlighted in red), Reboot button.
- Device Info:** MGMT IP: 192.168.1.4, MAC Address: 80C...45, SN: G1...379, Reye OS: [blank], Hardware Version: 1.00.
- Mode:** Normal, LED: [on], AP Location: LED blinking.
- Clients:** 3 total, 0 5G connected, 0 total connected.
- SSID:** @@@##111, 2.4G and 5G bands.
- Band:** 2.4G (Channel Auto, Transmit Power Auto) and 5G (Channel 40, Transmit Power Auto).

Username	SSID and Band	Signal Quality	IP/MAC	Negotiation Rate	Online Duration
No Data					

Total 0 | 1 | 10/page

Working Mode

Description:

1. The device IP address may change upon mode change.
2. Change the endpoint IP address and ping the device.
3. Enter the new IP address into the address bar of the browser to access Eweb.
4. The system menu varies with different work modes.

Working Mode (highlighted in red)

Self-Organizing Network

AC

(highlighted in red)

1.5.2 Configuration Steps

1. Add a Device to Network

You can manage and configure all devices in the network in batches by default. Please verify the device count and network status before configuration.

Note

New devices will join in a network automatically after being powered on. You only need to verify the device count.

If a new device is detected not in the network, click **Add to My Network** and enter its management password to add the device manually.

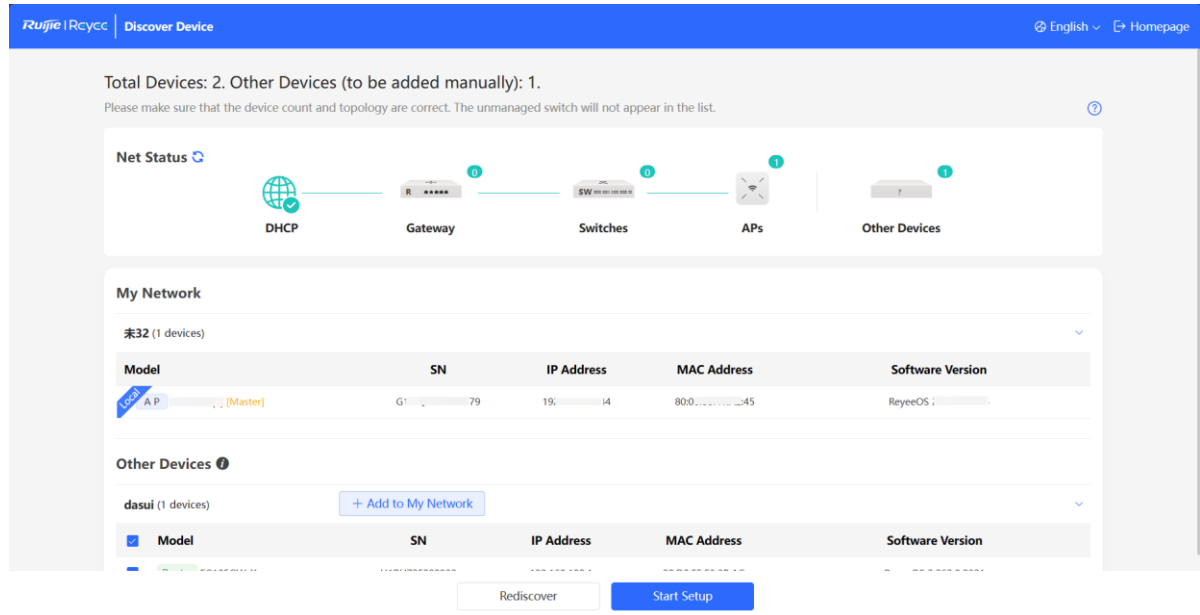

2. Creating a Network Project

(1) Click **Start Setup** to configure the Internet connection type and Wi-Fi network.

- **Internet:** Configure the Internet connection type according to requirements of the local Internet Service Provider (ISP).
 - **DHCP:** The access point detects whether it can obtain an IP address via DHCP by default. If the access point connects to the Internet successfully, you can click **Next** without entering an account.
 - **PPPoE:** Click **PPPoE**, and enter the username, password, and service name. Click **Next**.
 - **Static IP:** Enter the IP address, subnet mask, gateway, and DNS server, and click **Next**.
- **Wi-Fi Settings:** Select the Wi-Fi configuration mode. This configuration option is unavailable for a new project.
 - **Use Old Settings:** Use the Wi-Fi settings of an existing project.
 - **Use New Settings:** Configure the Wi-Fi network using new settings.
- **SSID and Wi-Fi Password:** The device has no Wi-Fi password by default, indicating that the Wi-Fi network is an open network. You are advised to configure a complex password to enhance the network security.
- **Country/Region:** The Wi-Fi channel may vary from country to country. To ensure that a client searches for a Wi-Fi network successfully, you are advised to select the actual country or region.
- **Time Zone:** Set the system time. The network time server is enabled by default to provide the time service. You are advised to select the actual time zone.

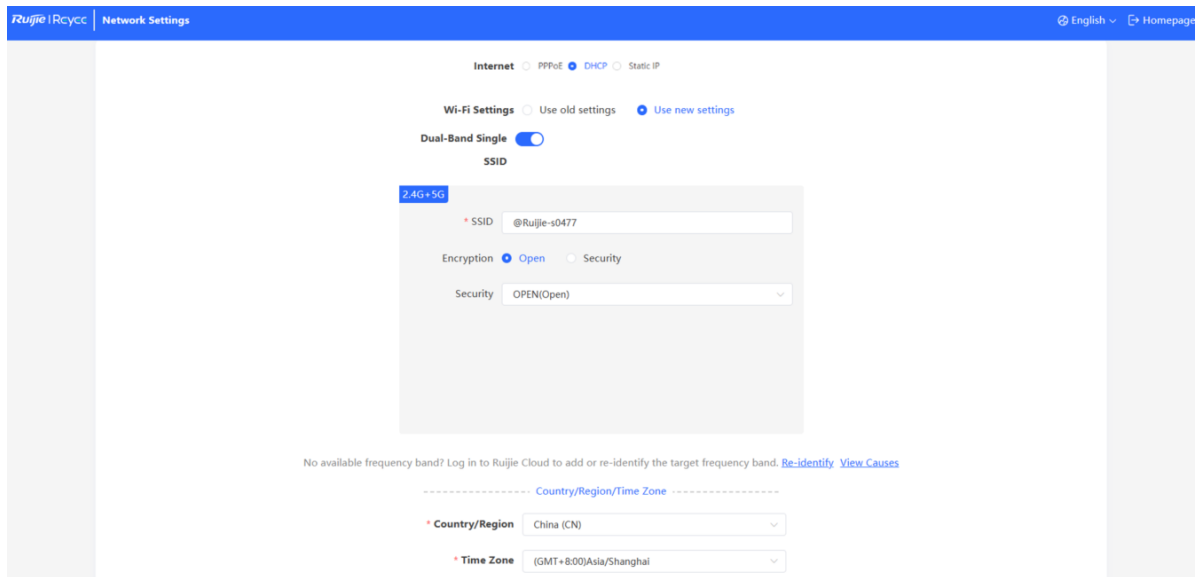

(2) Click **Next**. On the page that is displayed, set the project name and management password.

- **Project Name:** Identify the network project where the device is located.
- **Management Password:** The password is used for logging in to the management page.

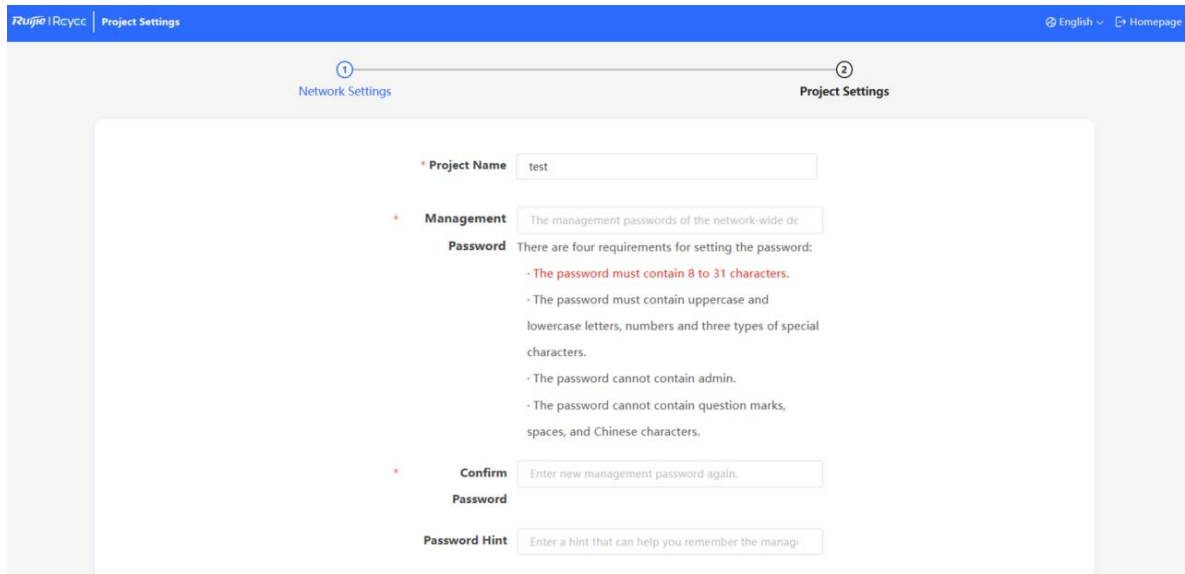

Click **Finish**. The device will deliver the initialization and check the network connectivity.

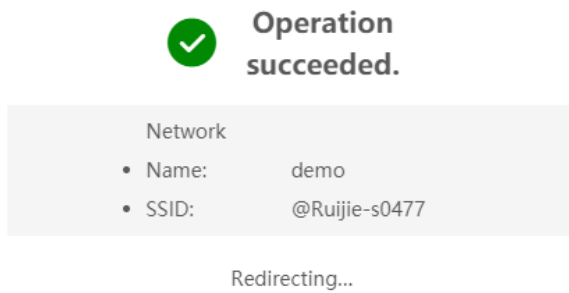

The device can access the Internet now. Bind the device with a Ruijie Cloud account for remote management. Follow the instruction to log in to Ruijie Cloud for further configuration.

Note

- If your device is not connected to the Internet, click **Exit** to exit the configuration wizard.
 - Please log in again with the new password if you change the management password.
-

1.6 Configuration Wizard (AP Mode)

1.6.1 Getting Started

- Power on the device and connect the device to an upstream device.
- Make sure that the device can access the Internet.

1.6.2 Configuration Steps

The device obtains the IP address through the DHCP by default. Configure the SSID, Wi-Fi password and management password. The default Internet connection type is DHCP mode. You are advised to use the default value.

The screenshot shows the Ruijie Cloud Network Settings interface. At the top, there are tabs for 'Internet' (with 'DHCP' selected) and 'Static IP'. Below that, 'Wi-Fi Settings' has 'Use old settings' and 'Use new settings' (selected). The 'Dual-Band Single' option is also selected. The SSID field contains '@Ruijie-s0477'. Under 'Encryption', 'Open' is selected, and the 'Security' dropdown is set to 'OPEN(Open)'. Below this, there is a message: 'No available frequency band? Log in to Ruijie Cloud to add or re-identify the target frequency band. [Re-identify](#) [View Causes](#)'. Further down, 'Country/Region' is set to 'China (CN)' and 'Time Zone' is set to '(GMT+8:00)Asia/Shanghai'. At the bottom, there are 'Previous' and 'Next' buttons.

1.7 Configuration Wizard (Wireless Repeater Mode)

1.7.1 Getting Started

- Before configuring the wireless repeater mode, configure the primary router and test that the primary router can access the Internet.
- Place the device where it can discover at least two-bar Wi-Fi signal of the primary router.

Caution

No Ethernet cable is required in the wireless repeater mode. The wireless network stability can be affected by many factors. Therefore, the wired connection is recommended.

1.7.2 Configuration Steps

- (1) Connect the device to a power supply without connecting an Ethernet cable to the uplink port, and click **Start Setup**.

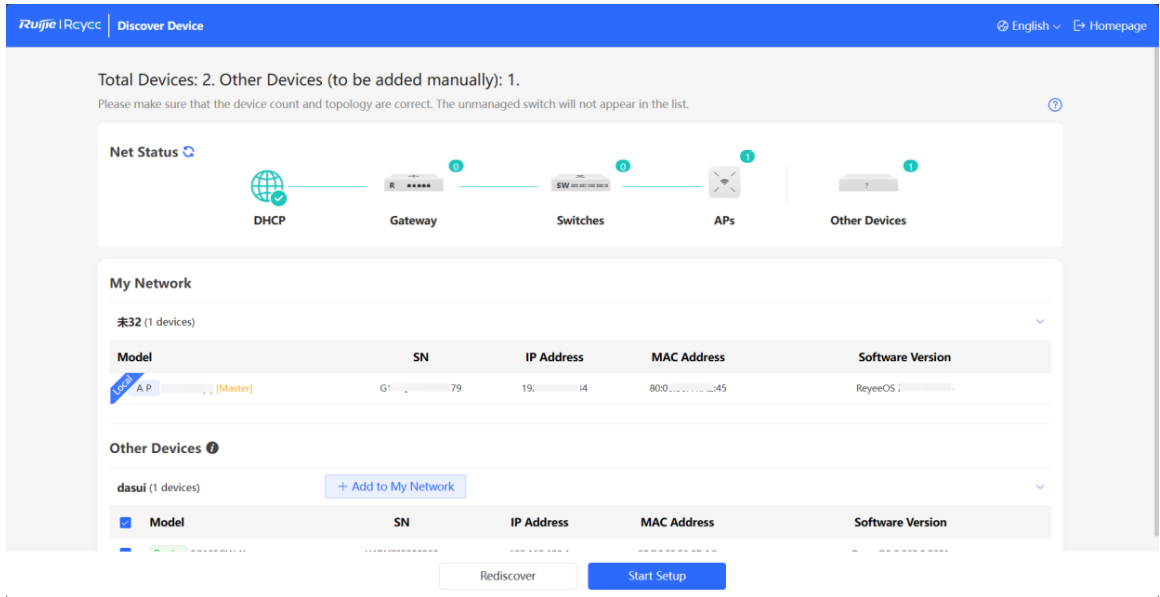

- (2) If you see a dialogue box indicating that the Ethernet cable is not connected to the WAN port, click **Wireless Repeater**.

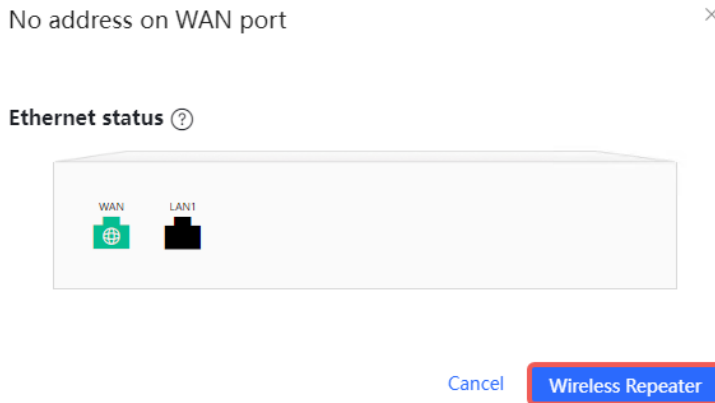

- (3) Select the primary router SSID that requires expanding the Wi-Fi coverage, enter the Wi-Fi password of the primary router, and click **Next**.

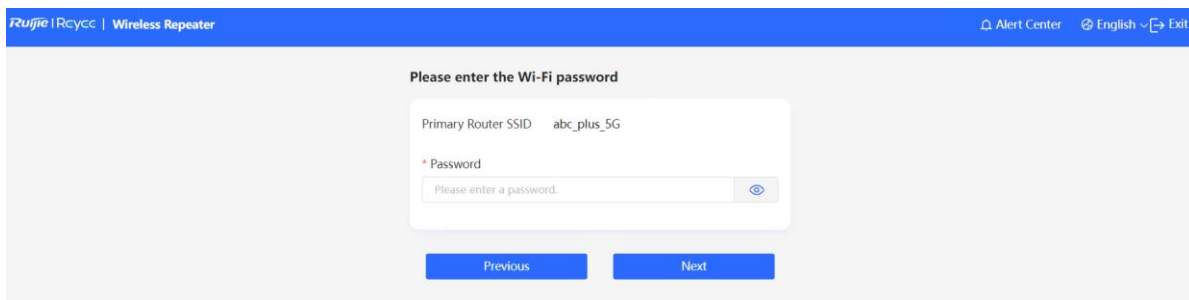
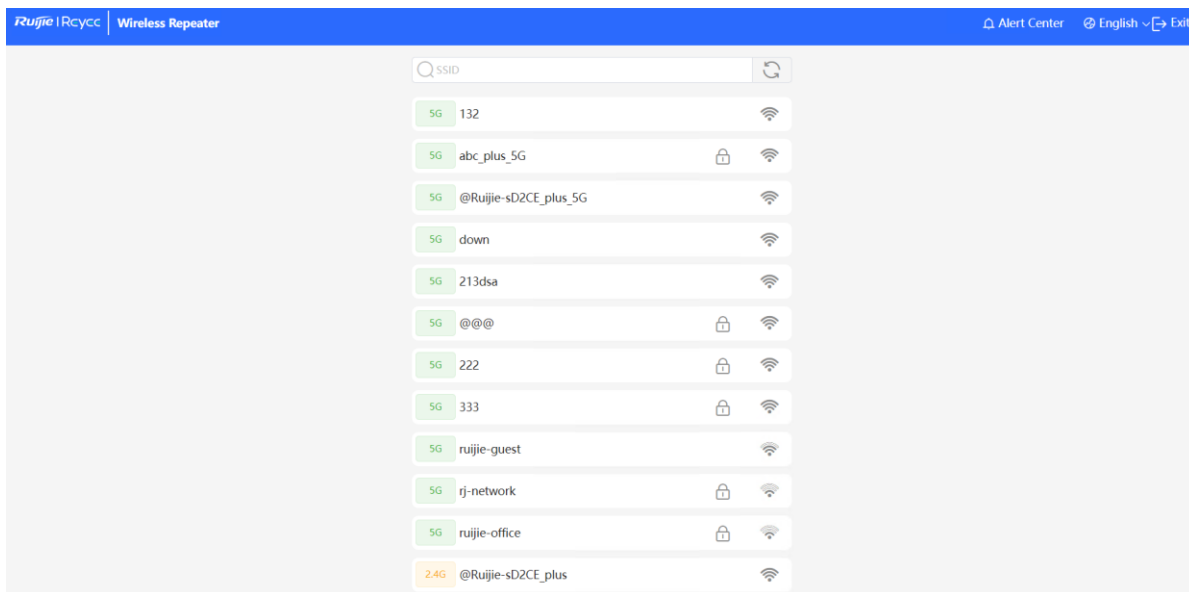

(4) Set the SSID and password and click **Save**. Then, the Wi-Fi network will be restarted.

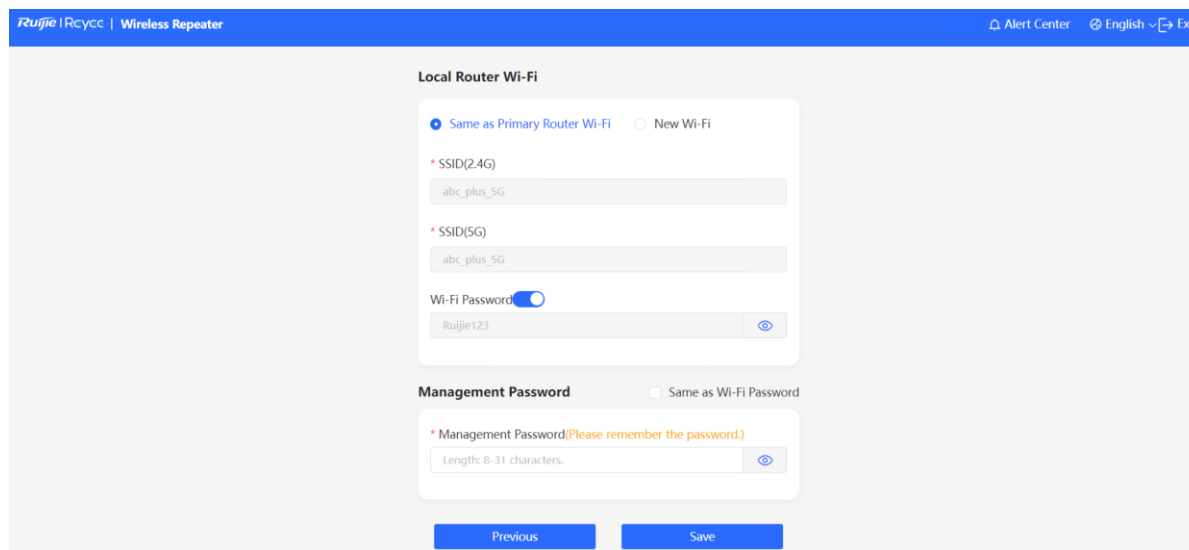

(5) Set the country/region code and time zone, and click **Save**.

The screenshot shows the 'Country/Region/Time Zone' configuration page in the Ruijie Wireless Repeater web interface. The page features a blue header with the Ruijie logo and navigation links. The main content area is a white box with a title 'Country/Region/Time Zone'. It contains two dropdown menus: 'Country/Region' with 'China (CN)' selected and 'Time Zone' with '(GMT+8:00)PRC' selected. Below the dropdowns are two blue buttons: 'Previous' and 'Save'.

1.8 Introduction to the Web Interface

To facilitate flexible device management, the Web page displays different system configuration menus in different work modes. For details about the work mode, see [4.1 Switching Work Mode](#).

As to the RG-RAP62-OD model, please refer to [1.8.1 Management Page for Wi-Fi 6 Products and Above](#).

Note

After the self-organizing network discovery function is enabled, the system configuration menus on the web interface depends on the master device on the network. If the master device supports Wi-Fi 6 or later, the web interface of the other devices on the network is the same as that of the master device.

The self-organizing network discovery function is enabled by default, but can be disabled manually. After this function is disabled, the web interface displays the local device mode.

When the self-organizing network discovery function is enabled, you can switch between the network-wide mode and the local device mode. The displayed function menus vary with the mode.

1.8.1 Management Page for Wi-Fi 6 Products and Above

1. Enabling Self-Organizing Network Discovery

- Network-Wide Mode: Displays the management information of all devices on the network. You can configure all devices on the network from a network-wide perspective.
- Local Device Mode: You can only configure the current logged in device.

Network-Wide Mode

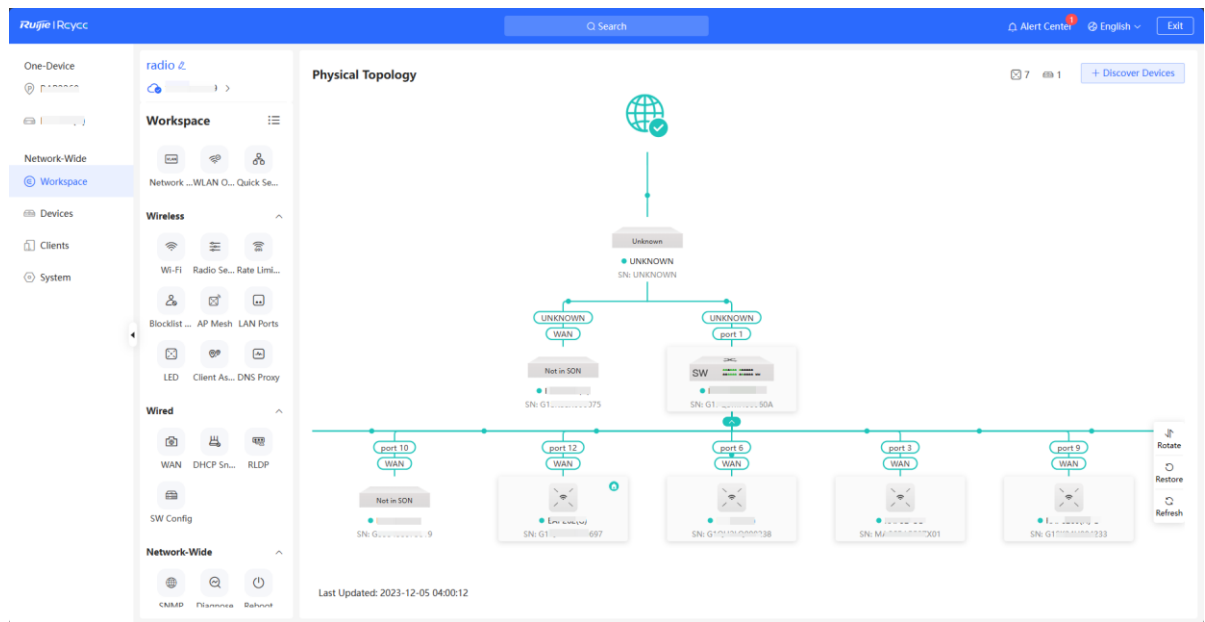

Local Device Mode

- To access the local device mode for the configuration and management of a single device, perform the following steps:
 - Method 1: Click the device name in the **One Device** menu and then click **Config**.

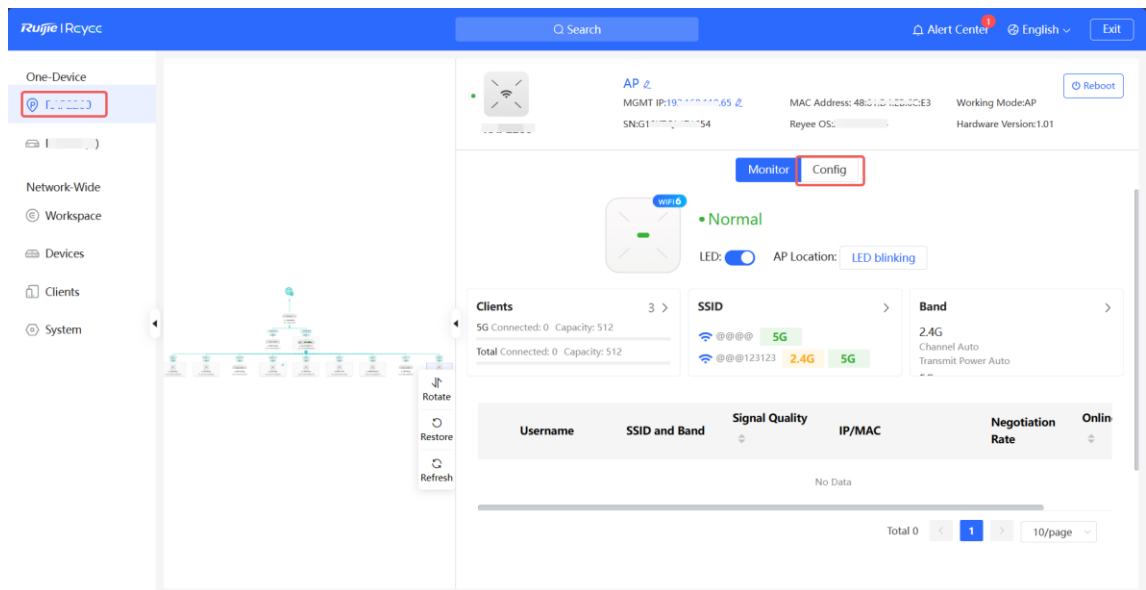

- Method 2: Choose **Network-Wide > Devices** and click **Manage** next to a device in the AP list.

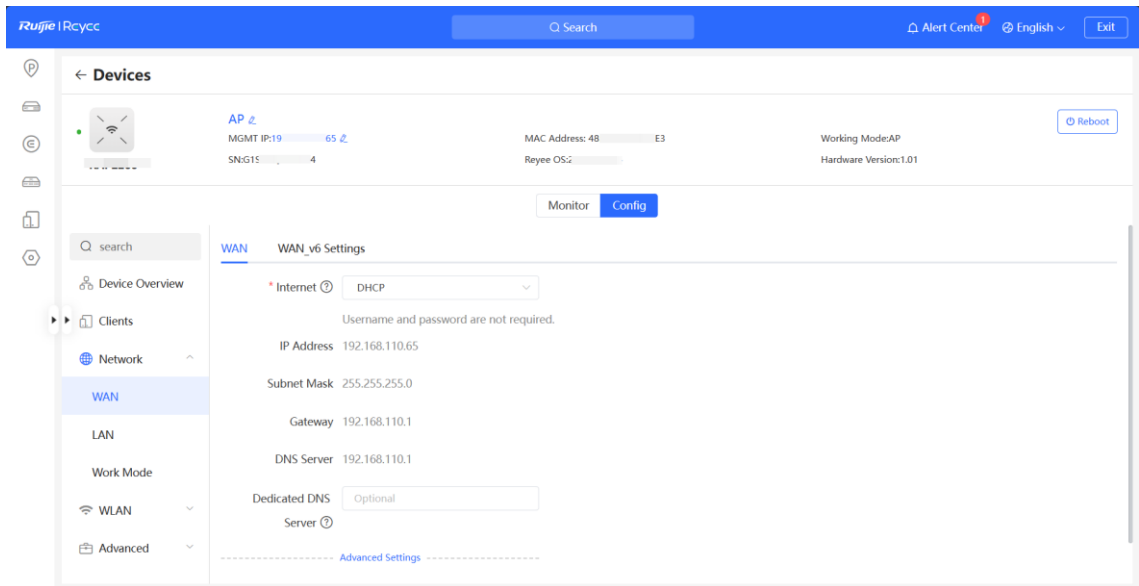
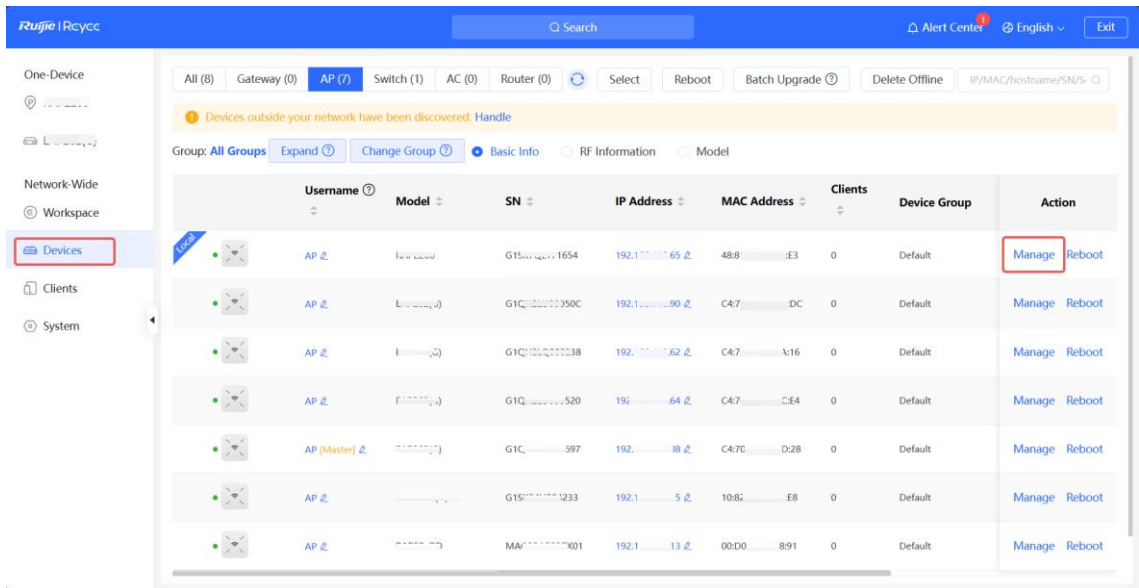

2. Disabling Self-Organizing Network Discovery

If a device is in standalone mode, you can configure and manage only the currently logged in device. The web interface displays the configuration menu of a single device on the left side.

The screenshot displays the Ruijie Rcycc web management interface. At the top, there is a navigation bar with the Ruijie logo, a search bar, and links for Cloud Service, Alert Center, Wizard, and English. The main content area is divided into several sections:

- Device Info:** Shows Memory Usage at 69%, Online Clients at 0, and Connection Status as Online. Uptime is 32 minutes 34 seconds, and System Time is 2023-12-05 15:12:26.
- Device Details:** Lists Model, MAC Address (48...), Software Version (ReyeeOS...), Device Name (Ruijie), Working Mode (AP), SN (G1...4), and Hardware Version (1.01).
- Wi-Fi:** Shows Primary Wi-Fi (Security: Yes) and Guest Wi-Fi (Security: No) with a toggle switch.
- Ethernet status:** Includes a diagram of the device with LAN2 and LAN1 ports.

A sidebar on the left contains a menu with 'Device Overview' highlighted in a red box, along with other options like Clients, Network, WLAN, Advanced, Diagnostics, and System.

2 Network Monitoring

Choose **Network-Wide > Workspace > Topology**.

The **Overview** webpage displays the current network topology, real-time uplink and downlink flow, networking status, and the number of users. The quick access to network and device settings is also provided on the **Overview** webpage. Users can monitor, configure and manage the network status on the current page.

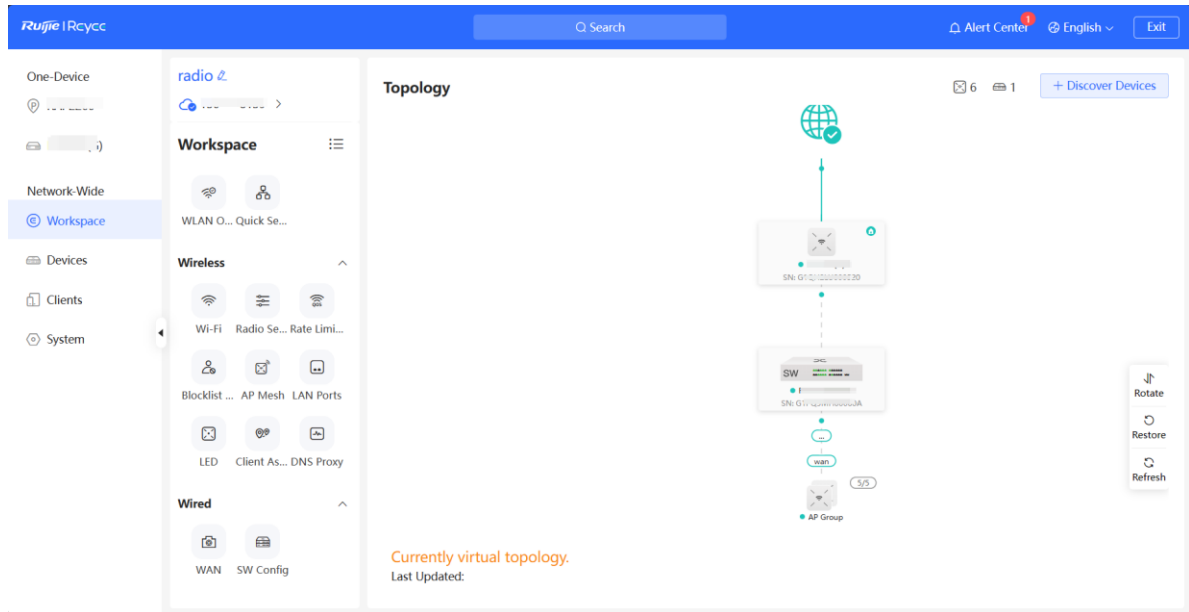

2.1 Viewing the Network Information

You can view the online device, port ID, device SN as well as the real-time uplink and downlink flow in the network topology.

Physical Topology

📁 1 📧 1 📄 2 📱 1 🖨 1 [+ Discover Devices](#)

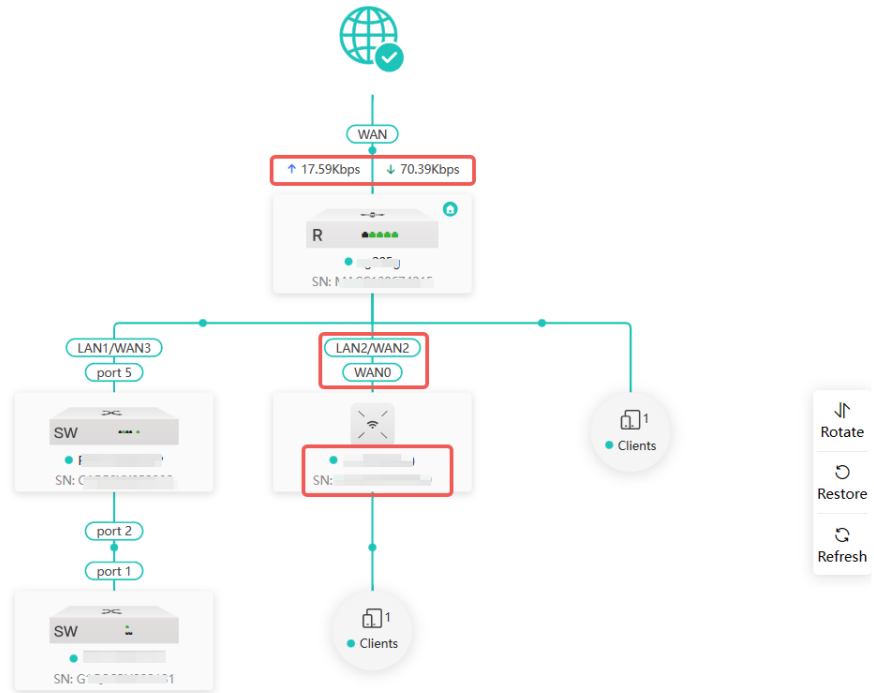



Last Updated: 2023-12-05 15:08:00

- Click the egress gateway to view real-time traffic information of the device.

Traffic Trend

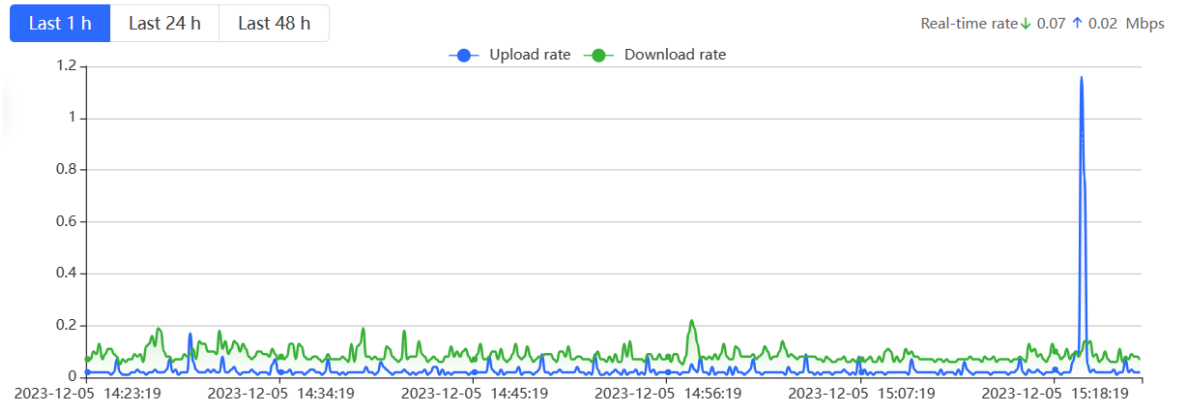
[More](#)



- Click the device in the topology to view the operating status and configuration of the device and configure the device functions. The hostname is set to the product model by default. You can click  to modify the hostname.

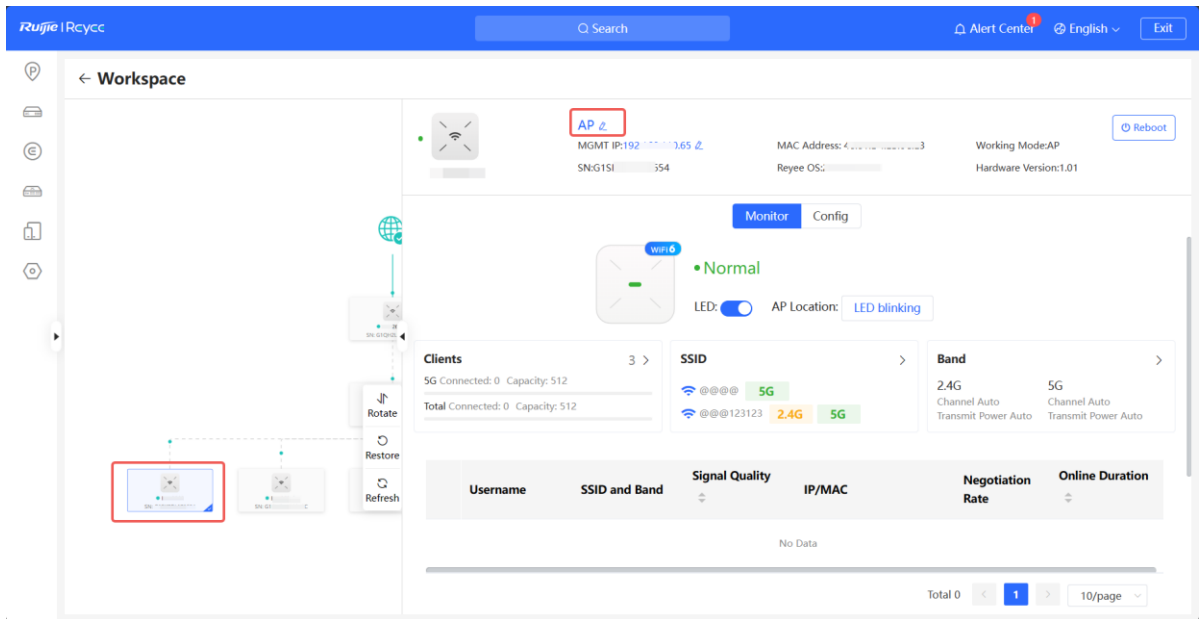

- The update time of the topology is displayed at the bottom left corner. Click **Refresh** to update the topology to the latest status. Please wait for a few minutes for the update.

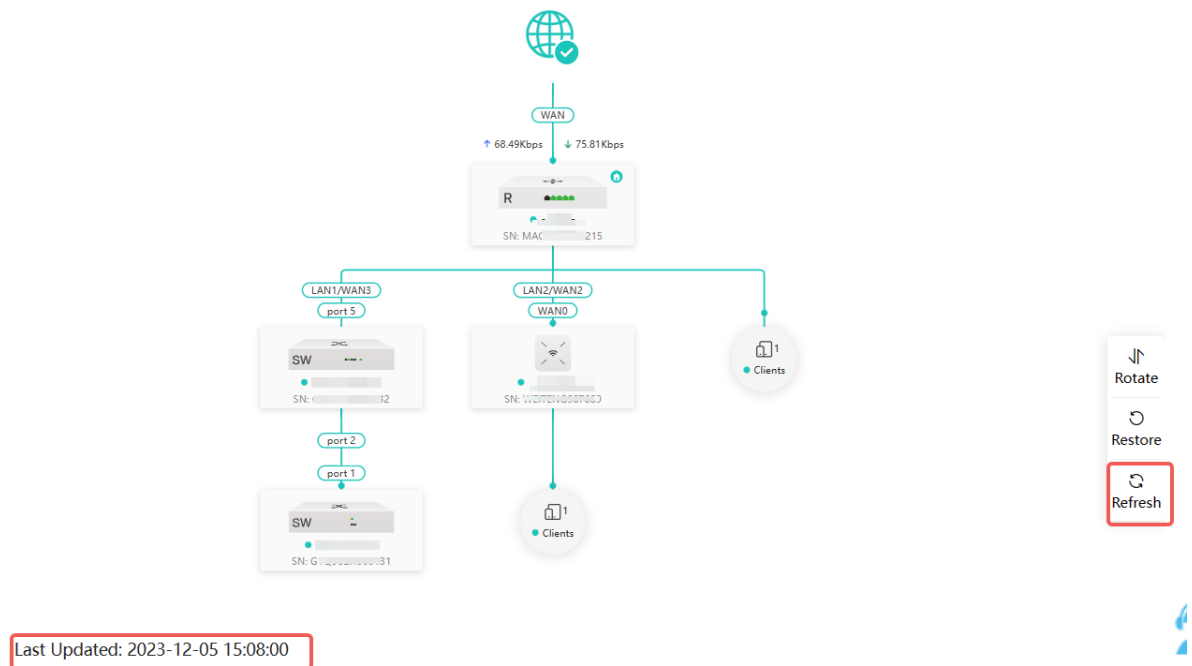

2.2 Adding Network Devices

2.2.1 Wired Connection

- (1) If a new device is connected to the device in the network through wired connection, a prompt message will pop up, indicating that a device not in SON (Self-Organizing Network) is discovered. The number (in orange)

of devices that are not in SON is displayed under the **Devices** at the top left corner of the page. Click **Handle** to add the device to the current network.

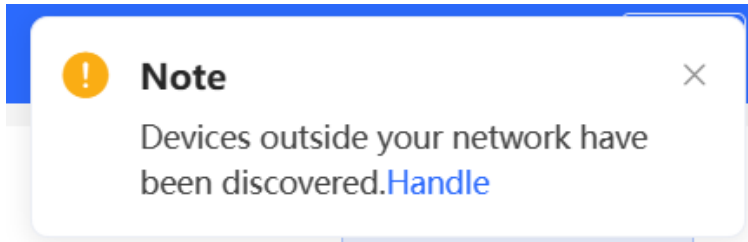

(2) Go to the **Network List** page, click **Other Network** to select the target device and click **Add to My Network**.

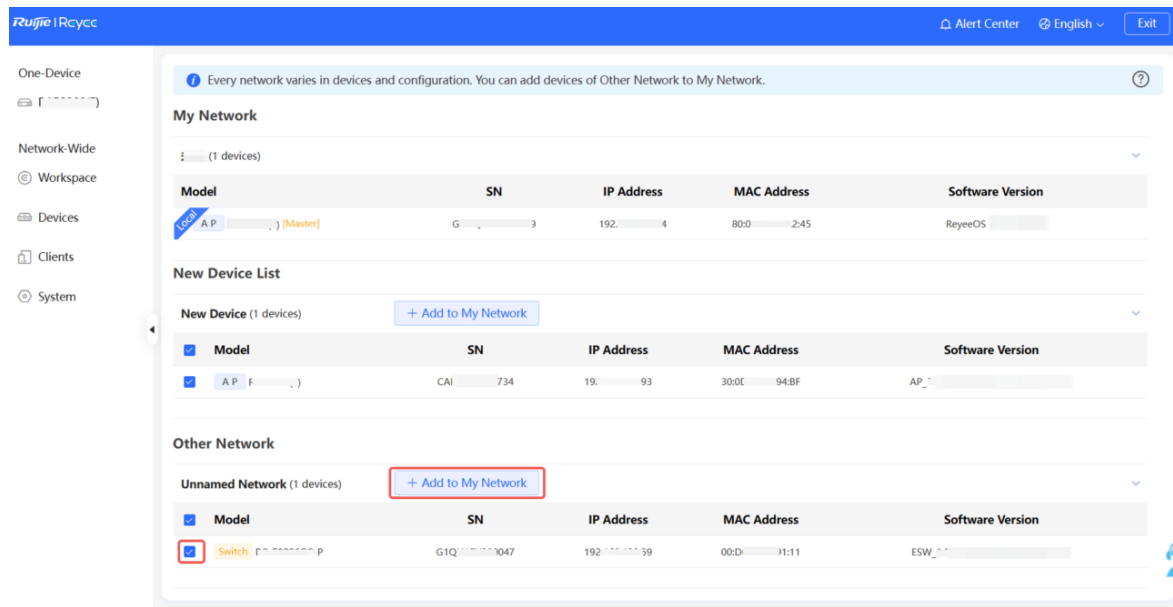

If the target device is not configured yet, you can add the device directly without a password. If the device is configured with a password, please enter the management password of the device. If the password is incorrect, the device cannot be added to the network.

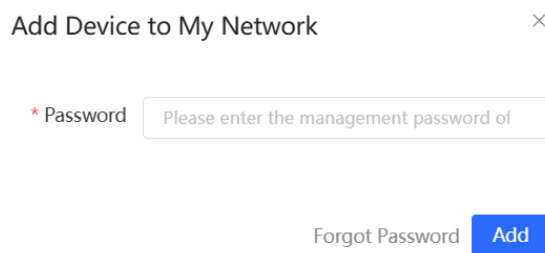

2.2.2 AP Mesh

1. Overview

After being powered on and enabled with Mesh (see [3.21 Enabling Reyee Mesh](#) for details), a Mesh-capable new AP can be paired with other Mesh-capable wireless devices on the target network through multiple ways.

Then the AP will be synchronized its Wi-Fi configuration with other devices automatically. Mesh networking addresses pain points such as complex wireless networking and cabling. A new AP can be connected to any uplink wireless device among AP, EG router, and EGW router in the following ways:

- Button-based pairing: Short press the Mesh button on the EGW router on the target network to implement fast pairing of the AP with the EGW router.
- Search-based pairing: Log in to the web interface of a device on the target network. Search and add APs to be paired.
- Wired pairing: Connect the new AP to a wireless device on the target network using an Ethernet cable. The new AP will go online on the target network.

After pairing finishes, the new AP obtains the wireless backhaul information from network-wide neighboring APs. Install the new AP as planned, and it will connect to the optimal neighboring AP.

2. Configuration Steps

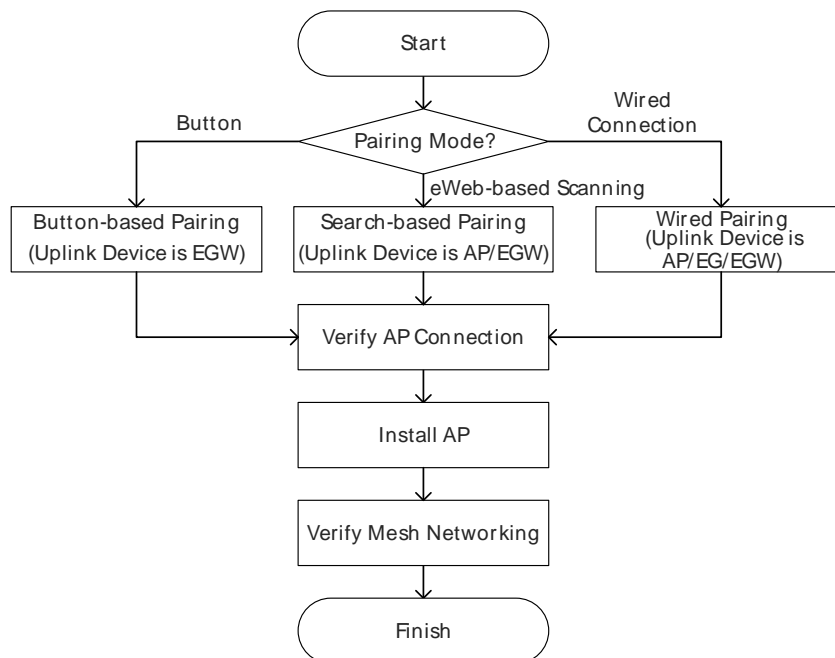

3. Configuration Steps for Button-based Pairing

⚠ Caution

- Uplink device is an EGW router.
- Only EG105GW-X and EG105GW(T) support button-based pairing and each router can be paired with up to 15 new APs.
- The master device must be properly configured. Otherwise, AP mesh failure may occur due to constant channel scanning.
- The new AP must be in factory status.
- It can be scanned only when the live network is enabled with Mesh (see 3.21 [Enabling Reyee Mesh](#) for details).
- Place the new AP no more than 2 meters away from the uplink device to ensure that the new AP can receive the Wi-Fi signal from the uplink device. The new AP may fail to be scanned due to the long distance or obstacles between it and the uplink device.

- (1) Power on the new AP and place it near the EGW router on the target network.
- (2) Press and hold the Mesh button  on the EGW router for no more than two seconds to start pairing. The pairing process takes about one minute.
- (3) Check the topology on the **Physical Topology** page to make sure that the new AP has connected to the uplink device in wireless mode.

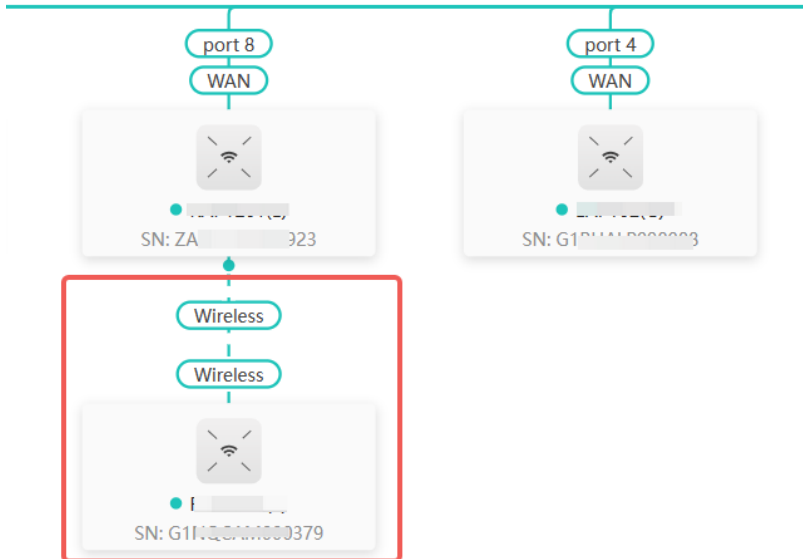

- (4) Power off the new AP and install it as planned.
- (5) Log in to the web interface of a device on the target network. In **Network-Wide** mode, choose **Devices > AP**.













Make sure that the new AP is online and the corresponding entry contains icon  in the **Relay Information** column. The icon indicates that wireless backhaul is performed through the 5 GHz radio.

All (54) Gateway (1) **AP (50)** Switch (2) AC (1) Router (0) 

Select Reboot Batch Upgrade  Delete Offline IP/MAC/hostname/SN/S-

 Devices outside your network have been discovered. [Handle](#)

Group: All Groups [Expand](#) [Change Group](#) Basic Info RF Information Model

	Username 	Model	Clients	Device Group	Relay Information 	Software Version 	Action
	AP ℹ		0	Default	 Wired View Details	ReyeeOS <input type="text"/>	Manage Reboot
	AP ℹ		0	Default	 Wired View Details	ReyeeOS <input type="text"/>	Manage Reboot
	AP ℹ		7	Default	 Wired View Details	ReyeeOS <input type="text"/>	Manage Reboot
	AP ℹ		0	Default	 Wired View Details	ReyeeOS <input type="text"/>	Manage Reboot
	AP ℹ		0	Default	 5G View Details	ReyeeOS <input type="text"/>	Manage Reboot

- (6) Click **View Details** following the  icon to obtain information about the uplink device and RSSI.

	AP 2		0	Default	Wired View Details
	AP 2		7	Default	Wired View Details
	AP 2		0	Default	Wired View Details
	AP 2		0	Default	5G View Details
	AP 2		0	Default	Wired View Details
	AP 2		0	Default	Wired View Details

Noise Floor: -82 dBm
 Channel Utilization: 16 %
 RSSI: -26 dBm **Good**
 Negotiation Rate: 173 Mbps
 Uptime: 13 minutes 18 seconds

Uplink 5G Local

AP AP

Model: I... Model: ...
 SN: ZAS...923 SN: G1NC...79
 IP: 192...155 IP: 192...131

4. Configuration Steps for Search-based Pairing

Caution

- Uplink device is an AP or EGW router.
- The master device must be properly configured. Otherwise, AP mesh failure may occur due to constant channel scanning.
- The new AP must be in factory status.
- It can be scanned only when the live network is enabled with Mesh (see [3.21 Enabling Reye Mesh](#) for details).
- Place the new AP no more than 2 meters away from the uplink device to ensure that the new AP can receive the Wi-Fi signal from the uplink device. The new AP may fail to be scanned due to the long distance or obstacles between it and the uplink device.

- (1) Power on the new AP and place it near the AP or EGW router on the target network.
- (2) Log in to the web interface of a device on the target network. In **Network-Wide** mode, click **+Discover Devices** in the upper right corner of the **Physical Topology** page to scan the APs in other networks not plugged in with Ethernet cables.

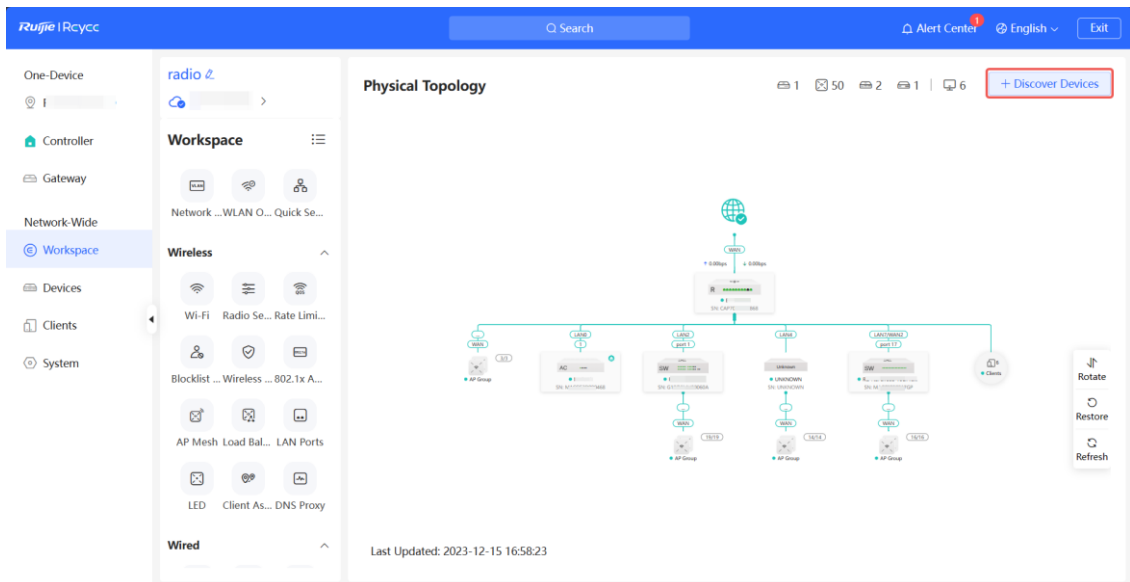

- (3) On the **AP Mesh** page, click **Scan** to scan devices that are not connected to the network via an Ethernet cable.

i Every network varies in devices and configuration. You can add devices of Other Network to My Network.

My Network

radio (53 devices)

Other Device

No data



- (4) Select the APs to be added and click **Add to My Network**. No more than eight APs are allowed at a time. Wait until network merging finishes.

dasui (2 devices) + Add to My Network

<input checked="" type="checkbox"/>	Model	SN	IP Address	MAC Address	Software Version
<input checked="" type="checkbox"/>	A P (.....)	ZA!.....55A	192.....56	ED:f.....13:85	ReyeeOS

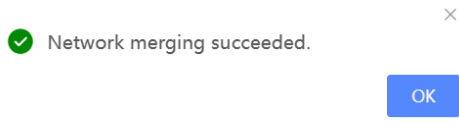



- (5) Check the topology on the **Physical Topology** page to make sure that the new AP has connected to the uplink device in wireless mode.

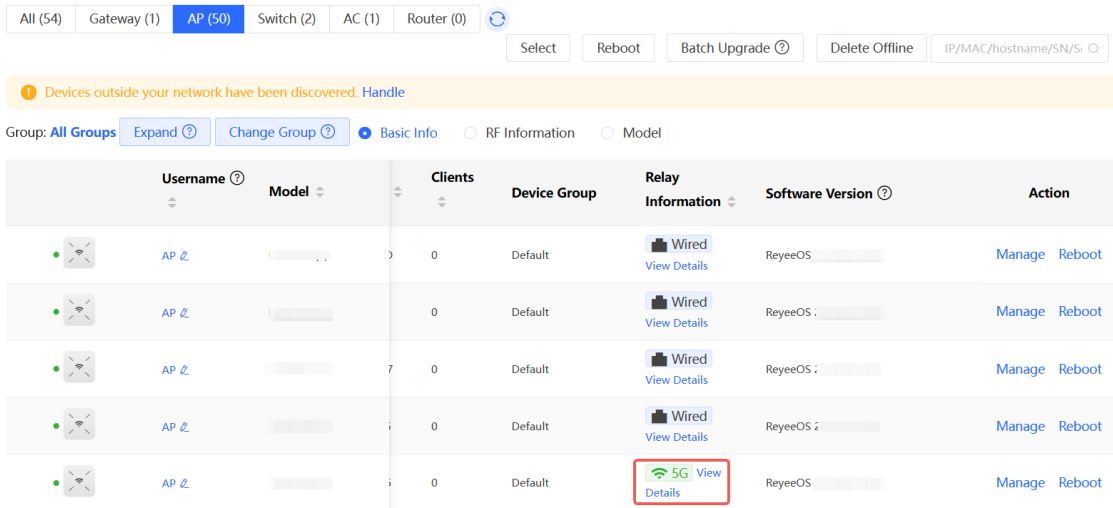

- (6) Power off the new AP and install it as planned.
- (7) Log in to the web interface of a device on the target network. In **Network-Wide** mode, choose **Devices > AP**.

Make sure that the new AP is online and the corresponding entry contains icon  in the **Relay Information** column. The icon indicates that wireless backhaul is performed through the 5 GHz radio.



- (8) Click **View Details** following the  icon to obtain information about the uplink device and RSSI.



5. Configuration Steps for Wired Pairing

Caution

- Uplink device is an AP, EG router, or EGW router.
- The new AP must be in factory status.
- It can be scanned only when the live network is enabled with Mesh (see [3.21 Enabling Reyee Mesh](#) for details).

- (1) Plug one end of the Ethernet cable to the uplink port of the new AP, and the other end to the downlink port of an AP, EG router, or EGW router on the target network. Mesh networking takes one to three minutes. When the system status LED is steady on, it indicates that Mesh networking finishes.
- (2) Log in to the web interface of a device on the target network. In **Network-Wide** mode, choose **Devices** and make sure that the new AP is online.

All (54) Gateway (1) **AP (50)** Switch (2) AC (1) Router (0)

Select Reboot Batch Upgrade Delete Offline IP/MAC/hostname/SN/S/...

Devices outside your network have been discovered. [Handle](#)

Group: **All Groups** [Expand](#) [Change Group](#) **Basic Info** RF Information Model

	Username	Model	SN	IP Address	MAC Address	Clients	Device Group	Action
	AP		G1...4233	19...15	10:8...:E8	0	Default	Manage Reboot
	AP		ZAS...0170	No IP Address Available	E0:...3:12:F1	0	-	Manage Reboot
	AP		G1N...0379	19...3.31	80:C...:245	0	Default	Manage Reboot

- (3) **Self-Healing Mesh** is disabled by default. You need to enable it first (for details, see [4.12 Configuring Self-Healing Mesh](#)) to complete the wired-to-wireless handoff process.
- (4) Unplug the Ethernet cable, power off the new AP, and install it as planned.
- (5) Log in to the web interface of a device on the target network. In **Network-Wide** mode, choose **Devices > AP**.

Make sure that the new AP is online and the corresponding entry contains icon in the **Relay Information** column. The icon indicates that wireless backhaul is performed through the 5 GHz radio.

All (54) Gateway (1) **AP (50)** Switch (2) AC (1) Router (0)

Select Reboot Batch Upgrade Delete Offline IP/MAC/hostname/SN/S/...

Devices outside your network have been discovered. [Handle](#)

Group: **All Groups** [Expand](#) [Change Group](#) **Basic Info** RF Information Model

	Username	Model	Clients	Device Group	Relay Information	Software Version	Action
	AP		0	Default	Wired View Details	ReyeeOS	Manage Reboot
	AP		0	Default	Wired View Details	ReyeeOS	Manage Reboot
	AP		0	Default	Wired View Details	ReyeeOS	Manage Reboot
	AP		0	Default	Wired View Details	ReyeeOS	Manage Reboot
	AP		0	Default	5G View Details	ReyeeOS	Manage Reboot

- (6) Click **View Details** following the icon to obtain information about the uplink device and RSSI.

	AP		0	Default	Wired View Details		
	AP		0	Default	Wired View Details		
	AP		0	Default	Wired View Details		
	AP		0	Default	5G View Details		
	AP		0	Default	Wired View Details		
	AP		0	Default	Wired View Details		

Noise Floor: -82 dBm
Channel Utilization: 16 %
RSSI: -26 dBm **Good**
Negotiation Rate: 173 Mbps
Uptime: 13 minutes 18 seconds

Uplink **5G** **Local**

AP AP

Model: I... SN: ZAS...923 IP: 192...155 Model: G1NC...79 SN: G1NC...79 IP: 192...31

6. Enabling WAN Port

The WAN port works as the wired uplink port of the AP by default. For the AP added to the target network through Mesh pairing, the WAN port is disabled by default. If you want to connect the Mesh AP to other downlink device in wired mode to expand the network, enable this port.

- Log in to the web interface of the network project. Choose **Network-Wide > Devices > AP**, and click **Manage** next to a device in the AP list.

The screenshot shows the AP management interface. At the top, there are tabs for 'All (54)', 'Gateway (1)', 'AP (50)', 'Switch (2)', 'AC (1)', and 'Router (0)'. Below the tabs are buttons for 'Select', 'Reboot', 'Batch Upgrade', 'Delete Offline', and a search field. A yellow notification bar states 'Devices outside your network have been discovered. Handle'. Below this, there are options for 'Group: All Groups', 'Expand', 'Change Group', and radio buttons for 'Basic Info', 'RF Information', and 'Model'. The main part of the interface is a table with the following columns: Username, Model, SN, IP Address, MAC Address, Clients, Device Group, and Action. The table contains three rows of AP data. The third row is highlighted with a red box, and its 'Manage' button is also highlighted with a red box.

Username	Model	SN	IP Address	MAC Address	Clients	Device Group	Action
AP		G1SK3-04233	192.168.0.45	10:82...:E8	0	Default	Manage Reboot
AP		ZASLA-170	No IP Address Available	E0:5D...2:F1	0	-	Manage Reboot
AP		G1NQCF-79	192.168.10.31	80:...:45	0	Default	Manage Reboot

- Choose **Config > Advanced > Enable WAN**, toggle on **Enable**, and click **Save**.

The screenshot shows the 'Enable WAN' configuration page. At the top, there is an information message: 'The WAN port is used as an uplink port of the AP by default. When the device works in the wireless repeater mode, the WAN port is disabled by default. If you want to extend network coverage through connecting the WAN port of the AP to a switch, enable the WAN port first.' Below the message is an 'Enable' toggle switch, which is currently turned on. At the bottom, there is a blue 'Save' button.

7. Querying Mesh APs and Mesh Details

- Log in to the web interface of a device on the target network.
- Query Mesh APs.
 - Method 1: In **Network-Wide** mode, check the topology on the **Physical Topology** page. The AP that connects to the uplink device in wireless mode is a Mesh AP.

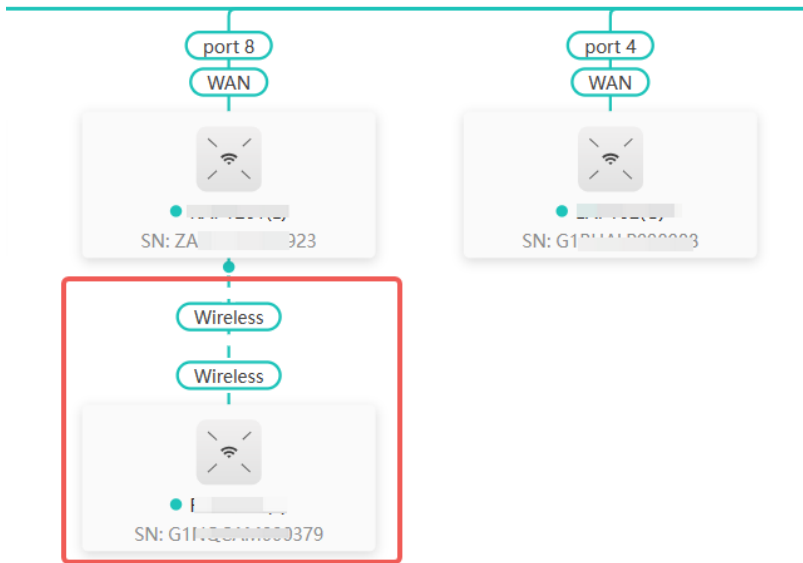

- Method 2: In **Network-Wide** mode, choose **Devices > AP**. If an entry contains icon  in the **Relay Information** column, the corresponding AP is a Mesh AP.

All (54) Gateway (1) **AP (50)** Switch (2) AC (1) Router (0) ↻

Select Reboot Batch Upgrade Delete Offline IP/MAC/hostname/SN/S-

Devices outside your network have been discovered. [Handle](#)

Group: All Groups Expand Change Group Basic Info RF Information Model

Username	Model	Clients	Device Group	Relay Information	Software Version	Action
AP		0	Default	Wired View Details	ReyeeOS	Manage Reboot
AP		0	Default	Wired View Details	ReyeeOS	Manage Reboot
AP		0	Default	Wired View Details	ReyeeOS	Manage Reboot
AP		0	Default	Wired View Details	ReyeeOS	Manage Reboot
AP		0	Default	 5G View Details	ReyeeOS	Manage Reboot

- (3) Query Mesh networking details.

In **Network-Wide** mode, choose **Devices > AP**. Select the target AP, and click **View Details** in the **Relay Information** column to obtain the Mesh networking details.

AP		0	Default	Wired View Details		
AP		0	Default	Wired View Details		
AP		0	Default	Wired View Details		
AP		0	Default	 5G View Details		
AP		0	Default	Wired View Details		
AP		0	Default	Wired View Details		

Noise Floor: -82 dBm
 Channel Utilization: 16 %
 RSSI: -26 dBm **Good**
 Negotiation Rate: 173 Mbps
 Uptime: 13 minutes 18 seconds

Uplink  Local

AP  AP

Model: I... Model: ...
 SN: ZAS...923 SN: G1NC...0000379
 IP: 192...155 IP: 192...0.31

2.3 Managing Network Devices

You can view information of all devices on the network. You can configure and manage all devices on the network by simply logging in to only one device on the network. Follow the following steps to access the device's management page:

- Method 1: Click the device icon in the upper right corner of the topology to switch to the device list view.

Physical Topology

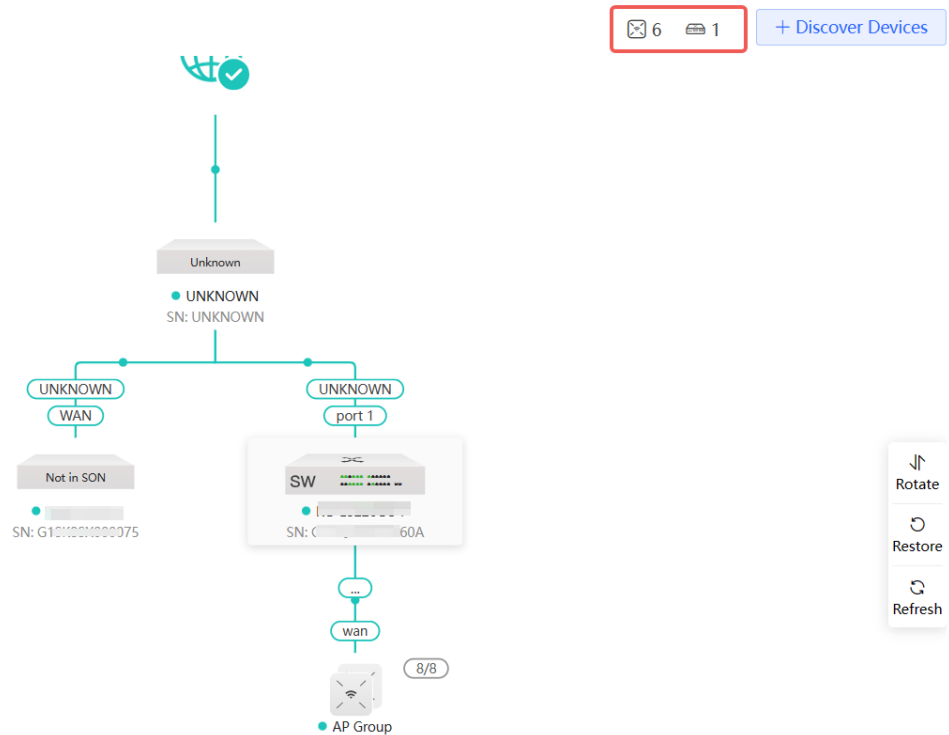

Last Updated: 2023-12-06 04:00:12

- Method 2: Choose **Network-Wide > Devices**.

Username	Model	SN	IP Address	MAC Address	Software Version	Action
AP	F...	G1SK...1654	192.1...65	48:8...E3	ReyeeOS...	Manage Reboot
AP	I...	G1S...4233	192.1...15	10:8...1:E8	ReyeeOS...	Manage Reboot
AP [Master]	I...	G1C...0520	192.1...2	C4:7...4CE4	ReyeeOS...	Manage Reboot
AP	I...	MA...ZX01	192.1...12	00:DC...:91	ReyeeOS 1...	Manage Reboot
AP	I...	G1C...50C	192.1...2	C4:7...C	ReyeeOS 2...	Manage Reboot
AP	I...	G1C...23B	192...62	C4:7...JA:16	ReyeeOS 4...	Manage Reboot
SW	Switch	G1P...A	192...54	30:0D...E3:E1	ESW_1...	Manage Reboot

- Click **Manage** to configure the selected device.

All (7) Gateway (0) AP (6) Switch (1) AC (0) Router (0) ↻
Select Reboot Delete Offline

⚠ Devices outside your network have been discovered. [Handle](#)

	Username ⓘ	Model	SN	IP Address	MAC Address	Software Version ⓘ	Action
Local	AP ↗		G1SK 654	192.1 ↗	48:8 :E3	ReyeeOS	Manage Reboot
	AP ↗		G1SI 004233	192. ↗	10:8 1:E8	ReyeeOS	Manage Reboot
	AP [Master] ↗		G1C 0520	192. ↗	C4:7 :4C:E4	ReyeeOS	Manage Reboot
	AP ↗		MAC 2ZX01	192. ↗	00:D 38:91	ReyeeOS	Manage Reboot
	AP ↗		G1Q 050C	192. ↗	C4:70 :4C:DC	ReyeeOS	Manage Reboot
	AP ↗		G1Q 0238	192. ↗	C4:70 A:16	ReyeeOS	Manage Reboot
	Switch ↗		G1PQ 0A	192	30:0D :E1	ESW_	Manage Reboot

Total 7 < 1 > 10/page

- Click **Select** to select an offline device, and click **Delete Offline** to remove the selected device from the list and the topology.

All (7) Gateway (0) AP (6) Switch (1) AC (0) Router (0) ↻
Select Reboot Delete Offline

⚠ Devices outside your network have been discovered. [Handle](#)

	Username ⓘ	Model	SN	IP Address	MAC Address	Software Version ⓘ	Action
Local	AP ↗		G1S 4	19: ↗	48: :	ReyeeOS	Manage Reboot

All (7) Gateway (0) AP (6) Switch (1) AC (0) Router (0) ↻
Deselect Reboot Delete Offline

⚠ Devices outside your network have been discovered. [Handle](#)

	Username ⓘ	Model	SN	IP Address	MAC Address	Software Version ⓘ	Action
Local	<input checked="" type="checkbox"/> AP ↗		G1S 654	192.11 5 ↗	48:81:	ReyeeOS	Manage Reboot

2.4 Configuring Network Planning

Choose **Network-Wide > Workspace > Network Planning**.

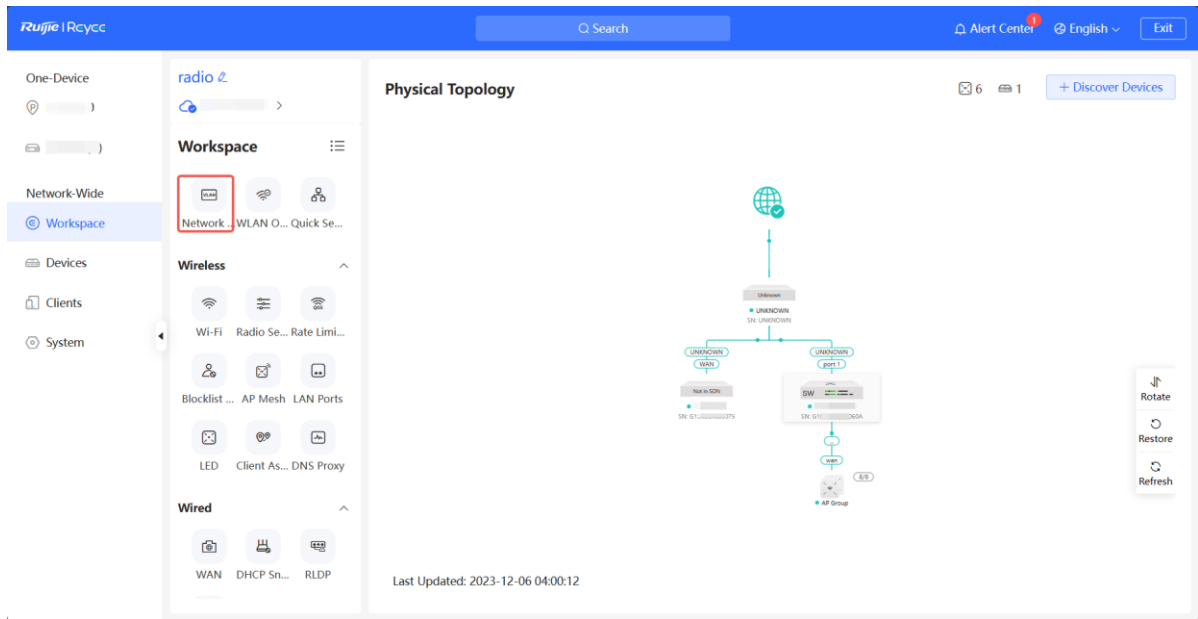

Click the SSID to edit the Wi-Fi configuration. For details, see Chapter 3 [Wi-Fi Network Settings](#).

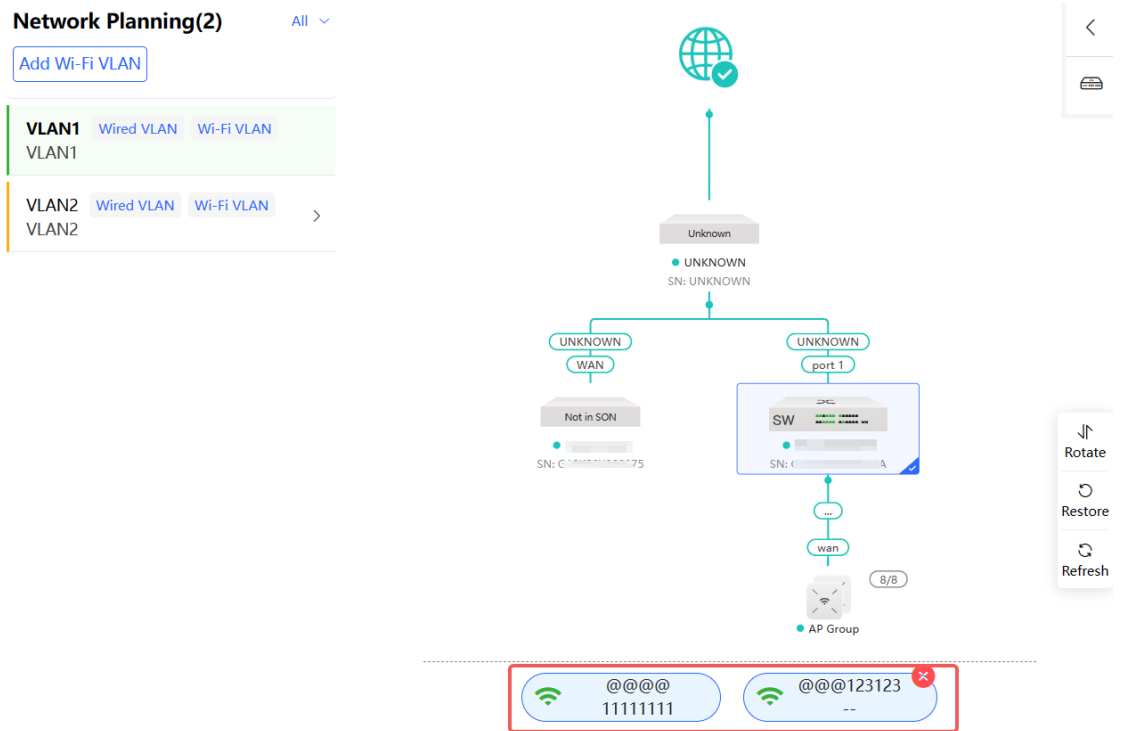

Edit Wi-Fi VLAN



* SSID ?

Purpose ? **General** | IoT | Guest

Band ? 2.4G 5G

No available frequency band? Log in to Ruijie Cloud to add or re-identify the target frequency band. [Re-identify](#) [View Causes](#)

Encryption Open Security 802.1x (Enterprise) !

* Security ?

* Wi-Fi Password

----- advanced Setting -----

Cancel

OK

2.4.1 Configuring Wired VLAN

Choose **Network-Wide > Workspace > Network Planning**.

On the **Network Planning** page, click **Add Wired VLAN**.

Network Planning(1) All ▼

Add Wired VLAN Add Wi-Fi VLAN

VLAN1 Wi-Fi VLAN

VLAN1

SVI Address: (Gateway)
192.168.110.1

DHCP Pool (Enable)
192.168.110.1/255.255.255.0
IP Count: 254
Lease Time (Min): 30

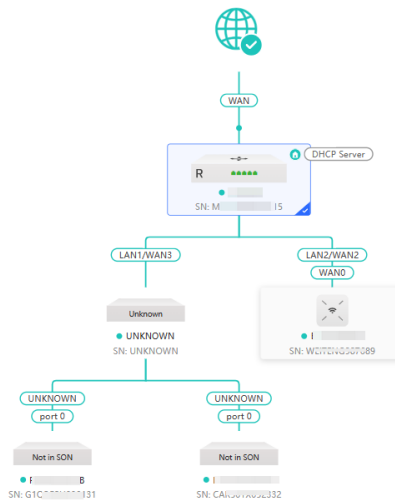

<

Rotate

Restore

Refresh

@@@@ @@@@@@

Alternatively, you can select an existing wired VLAN and click **Setup** to edit the VLAN.

Network Planning(2) All ▼

[Add Wired VLAN](#) [Add Wi-Fi VLAN](#)

VLAN1 Wi-Fi VLAN >

VLAN1

VLAN10
test

SVI Address: (Gateway)
192.168.10.1

DHCP Pool (Enable)
192.168.10.1/255.255.255.0
IP Count: 254
Lease Time (Min): 480

Setup

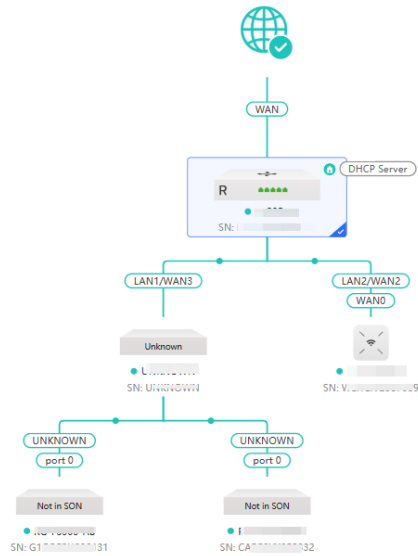

- (1) Configure the VLAN ID, address pool server, and DHCP pool. The gateway is configured as the address pool server by default to assign IP addresses to clients. If an access switch exists in the network, you can select the access switch as the address pool server. Click **Next** after VLAN parameters are configured.

Configure Network Planning/Add Wired VLAN ×

1 Configure VLAN Parameters 2 Configure Wired Access 3 Confirm Config Delivery

Description:

* VLAN ID:

Address Pool Gateway

Server

Gateway/Mask: /

DHCP Pool:

IP Range: -

Next

- (2) Select the target switch in the topology and all member ports in the VLAN, and click **Next**.

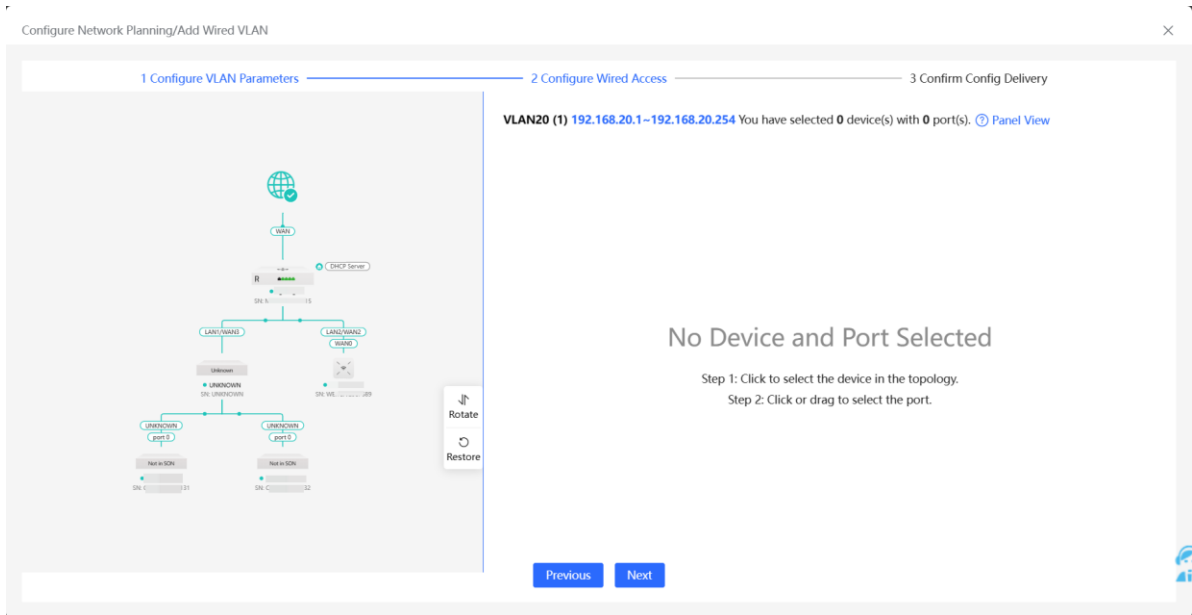

(3) Please confirm the delivered configurations and click **Save**. The configurations will take effect after a few minutes.

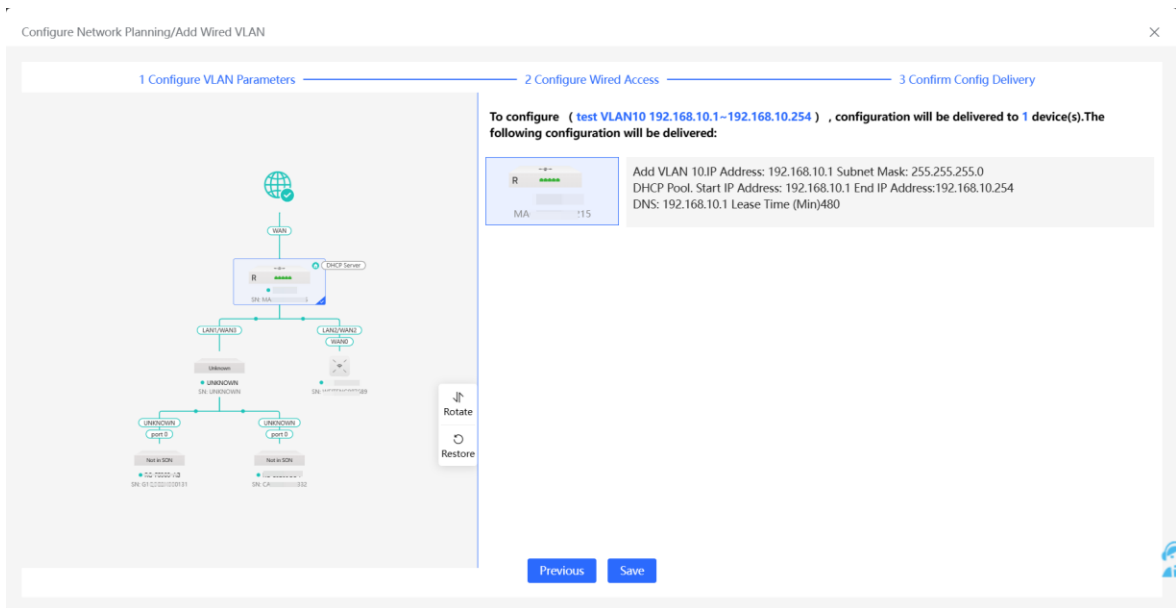

2.4.2 Configuring Wi-Fi VLAN

Choose **Network-Wide > Workspace > Network Planning**.

On the **Network Planning** page, click **Add Wi-Fi LAN**.

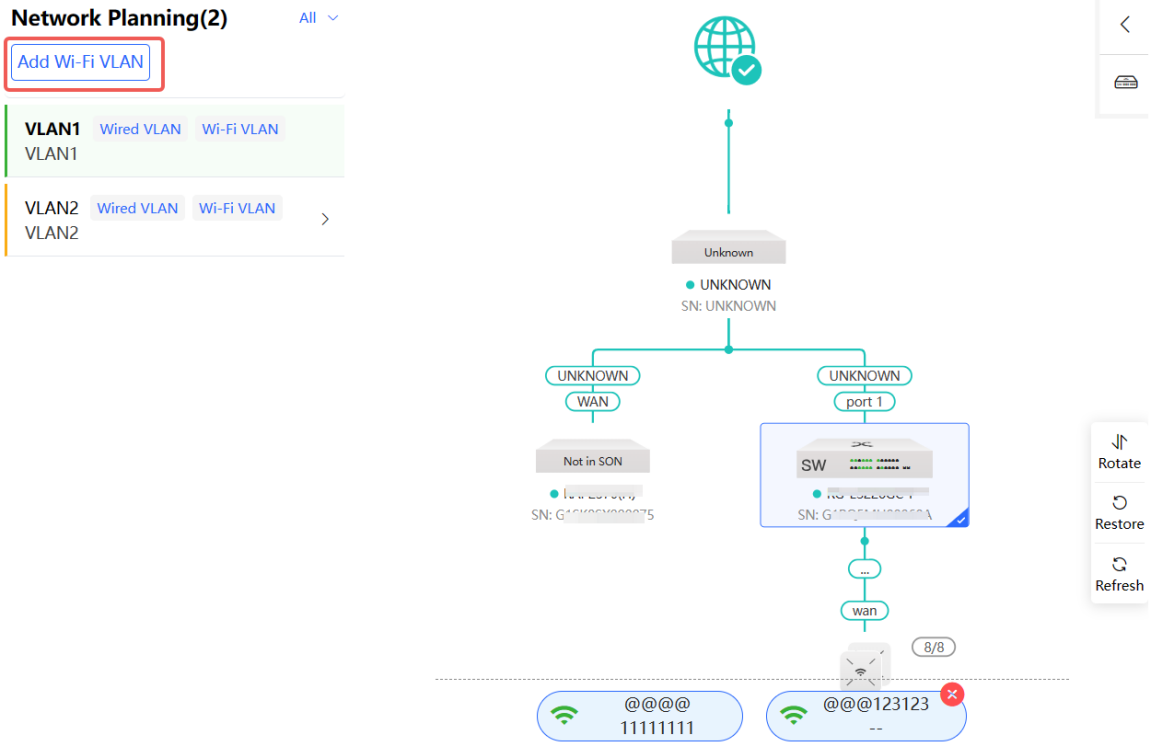

Alternatively, you can select an existing wireless VLAN and click **Setup** to edit the VLAN.

- Configure the SSID, Wi-Fi password and band. Click **Expand** to expand the advanced settings and set the parameters. Then, click **Next**.

Configure Network Planning/Add Wi-Fi VLAN

1 Configure Wireless Access | 2 Configure VLAN Parameters | 3 Confirm Config Delivery

i The configuration will take effect after being delivered to AP.

* SSID

Band 2.4G + 5G 2.4G 5G

Security

[Collapse](#)

Wireless Schedule

Hide SSID (The SSID is hidden and must be manually entered.)

Client Isolation Prevent wireless clients of this Wi-Fi from communicating with one another.

Band Steering (The 5G-supported client will access 5G radio preferentially.)

XPress (The client will faster speed.)

Next

- (2) Configure the VLAN ID, address pool server and DHCP pool. The gateway is configured as the address pool server by default to assign IP addresses to clients. If an access switch exists in the network, you can select the access switch as the address pool server. Click **Next** after VLAN parameters are configured.

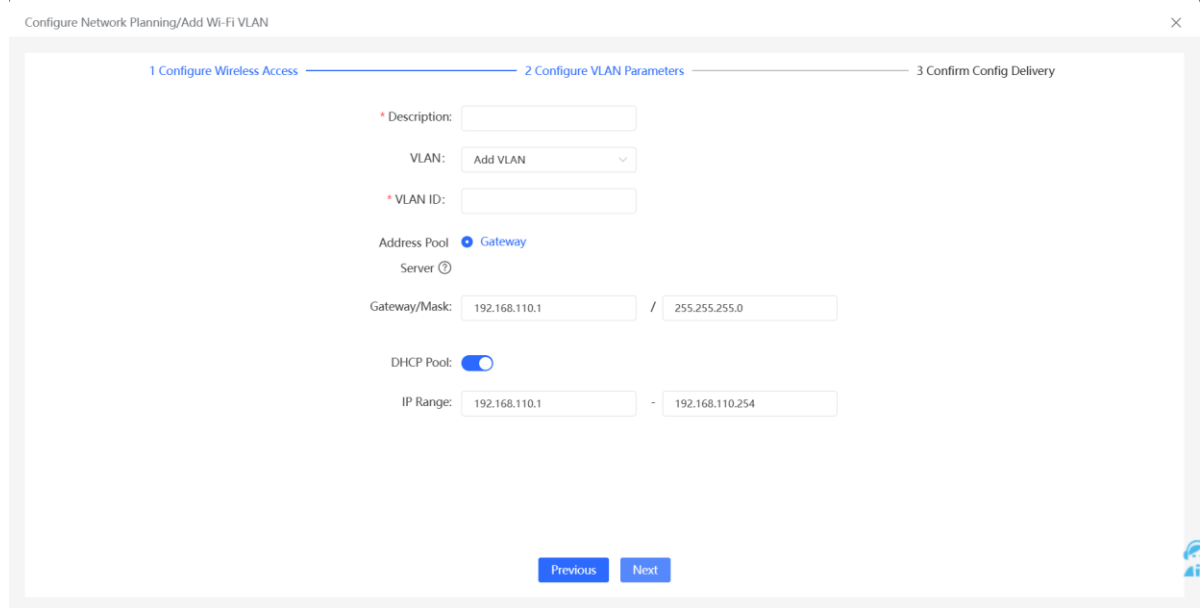

- (3) Please confirm the delivered configurations and click **Save**. The configurations will take effect after a few minutes.

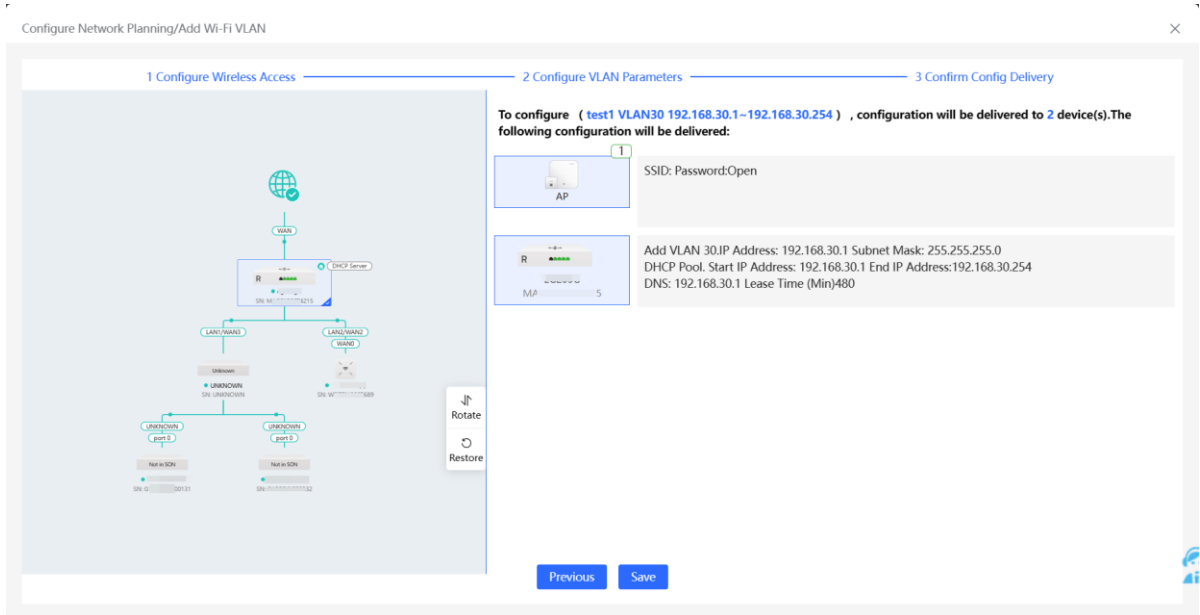

3 Wi-Fi Network Settings

Note

Wi-Fi network settings covers the Wi-Fi settings of the currently logged in devices and the management of all wireless devices in the network. In **Network** mode, the Wi-Fi network settings are synchronized to all wireless devices in the network. You can configure device groups to limit the synchronization range. For details, see [3.1 Configuring AP Groups](#).

3.1 Configuring AP Groups

3.1.1 Overview

After the self-organizing network is enabled, the device can act as the master AP/AC to perform batch configuration and management on the downlink APs in groups. Group the APs before the configurations are delivered.

Note

If you specify a group when setting up a wireless network, the corresponding configuration will take effect on the wireless devices in the specified group.

3.1.2 Configuration Steps

Choose **Network-Wide > Devices > AP**.

(1) The **AP** page displays all APs on the network. Click **Manage** to configure the selected device.

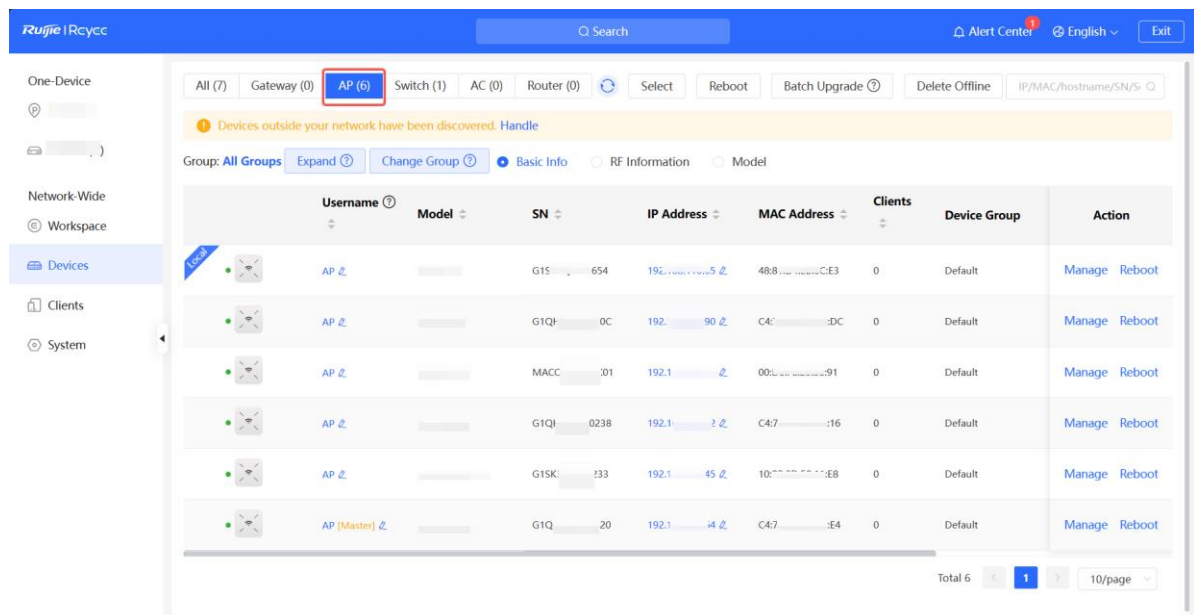

(2) Click **Expand** to view all device groups on the left section of the **Devices** page.

AP (6) | Switch (1) | AC (0) | Router (0) | Select | Reboot | Batch Upgrade | Delete Offline | IP/MAC/hostname/SN/Sr

Devices outside your network have been discovered. Handle

Group: All Groups **Expand** Change Group Basic Info RF Information Model

Username	Model	SN	IP Address	MAC Address	Clients	Device Group	Action
AP		G1...	192...	48:81:...	0	Default	Manage Reboot

(3) Click to create a new group. Up to 8 groups can be added. You can click to edit the group name and click to delete the group. The default group cannot be deleted and its name cannot be edited.

All (7) | Gateway (0) | AP (6) | Switch (1) | AC (0) | Router (0) | Select | Reboot | Batch Upgrade | Delete Offline | IP/MAC/hostname/SN/Sr

Devices outside your network have been discovered. Handle

Group: All Groups Collapse Change Group Basic Info RF Information Model

Search by Group

- All Groups
- Default
- 2

Username	Model	SN	IP Address	MAC Address	Clients	Action
AP	F	G1S...1654	192...5	48:81:...C:E3	0	Manage Reboot
AP	E	G1C...0C	192...0	C4:7C...C:DC	0	Manage Reboot
AP		MA...	192...13	00:D0...38:91	0	Manage Reboot
AP		G1QI...3	192...2	C4:71...0A:16	0	Manage Reboot
AP		G1S...233	192...5	10:82...1:E8	0	Manage Reboot
AP [Master]	E	G1Q...520	19...4	C4:70...4C:E4	0	Manage Reboot

Total 6 | 1 | 10/page

(4) Click the group name on the left part to view all devices in this group. A device can only belong to a group. By default, all devices belong to the default group. Select an entry in the list and click **Change Group** to move the target device to a specified group, and then the device will apply the configurations of this group. Click **Delete Offline Devices** to remove the offline device from the list.

All (7) | Gateway (0) | AP (6) | Switch (1) | AC (0) | Router (0) | Deselect | Reboot | Batch Upgrade | Delete Offline | IP/MAC/hostname/SN/Sr

Devices outside your network have been discovered. Handle

Group: All Groups Collapse Change Group Basic Info RF Information Model

Search by Group

- All Groups
- Default
- 2

Username	Model	SN	IP Address	MAC Address	Action
<input checked="" type="checkbox"/> AP		G1S...654	192...065	48:81:...C:E3	Manage Reboot
<input type="checkbox"/> AP		G1QH...C	192...0	C4:7C...C:DC	Manage Reboot

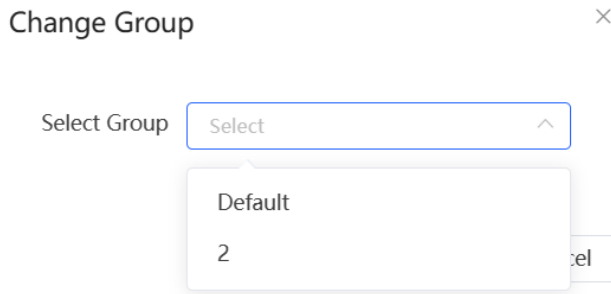

3.2 Adding a Wi-Fi Network

(1) Go to the page for configuration.

- Method 1: Choose **Network-Wide > Workspace > Wireless > Wi-Fi > Wi-Fi List**.
- Method 2: Choose **One-Device**. Click the device model, and choose **Config > WLAN > Wi-Fi > Wi-Fi List**.

(2) Click **Add Wi-Fi**.

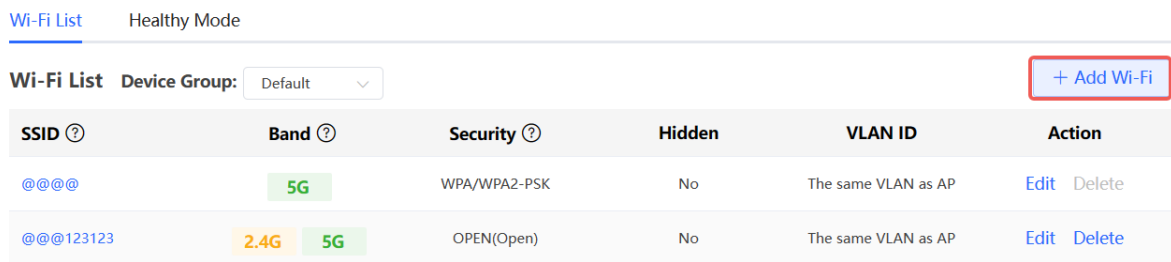

Up to 8 SSIDs can be added.

(3) Configure the SSID, password, and other information.

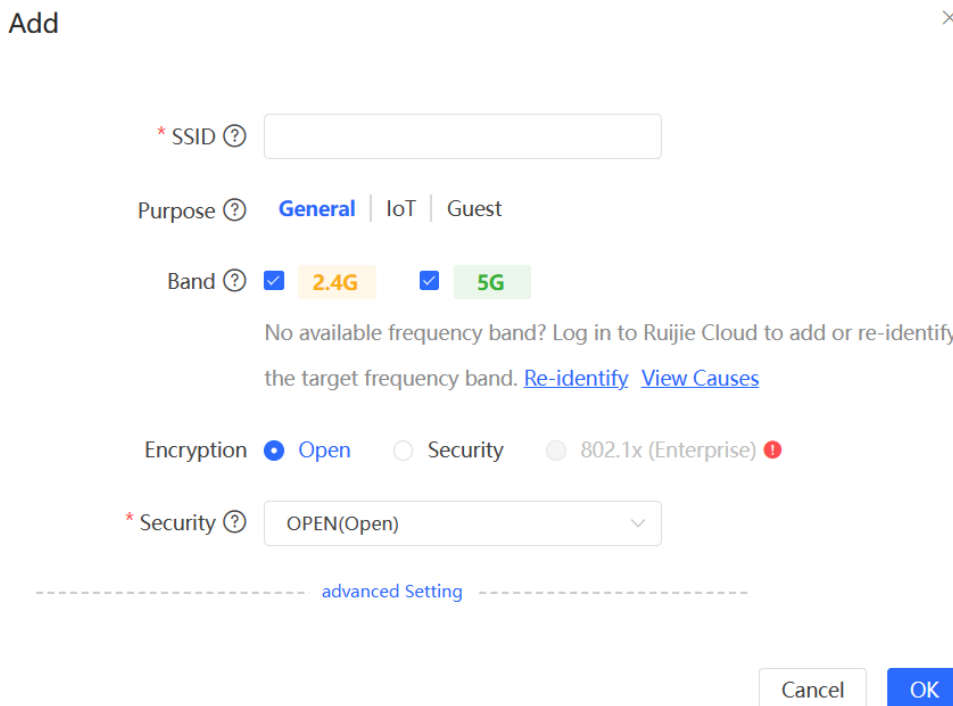

- (4) Click **advanced Settings** to configure more Wi-Fi parameters. After configuration, click **OK**. After the Wi-Fi is added, a client can detect the SSID, and the Wi-Fi information is displayed in the Wi-Fi list.

----- advanced Setting -----

Wi-Fi Standard ⓘ

Wireless Schedule ⓘ

VLAN

Hide SSID (The SSID is hidden and must be manually entered.)

Client Isolation ⓘ (Prevent wireless clients of this Wi-Fi from communicating with one another.)

Band Steering (The 5G-supported client will access 5G radio preferentially.)

XPress (The client will experience faster speed.)

Layer 3 Roaming ⓘ (The client will keep the IP address unchanged on the Wi-Fi network.)

LimitSpeed

[Do you want to edit RF parameters? Navigate to Radio Frequency for configuration.](#)

Table 3-1 Wi-Fi Configuration Parameters

Parameter	Description
SSID	Enter the name displayed when a wireless client searches for a wireless network.
SSID Encoding	The SSID encoding standard is set to "UTF-8" by default when Chinese characters are included in the SSID. If the Chinese characters are garbled, you can choose "GBK" as the SSID encoding standard.
Purpose	Set the Wi-Fi usage scenario. The options include General , IoT , and Guest . The system will recommend different Wi-Fi parameter combinations based on the selected purpose.

Parameter	Description
Band	Set the band used by the Wi-Fi signal. The options are 2.4 GHz and 5 GHz. The 5 GHz band provides faster network transmission rate and less interference than the 2.4 GHz band, but is inferior to the 2.4 GHz band in terms of signal coverage range and wall penetration performance. Select a proper band based on actual needs. The default value is 2.4G + 5G , indicating that the device provides signals at both 2.4 GHz and 5 GHz bands.
Encryption	Select an encryption mode for the wireless network connection. The options are as follows: <ul style="list-style-type: none"> ● Open: No password is required to connect to the Wi-Fi network. The encryption type is OPEN. ● Security: The encryption types include WPA-PSK, WPA/WPA2-PSK, WPA2-PSK, WPA2-PSK/WPA3-SAE, and WPA3-SAE ● 802. 1x (Enterprise): The encryption types include WPA-802. 1X, WPA/WPA2-802. 1X, and WPA2-802. 1X.
Wi-Fi Password	When the Security is set to WEP, you need to set the password for connecting to the wireless network. The password is a string of 8 to 16 characters.
Select server group	When the Encryption is set to 802. 1x (Enterprise) , you need to configure a remote server set for authentication and authorization.
Wi-Fi Standard	The Wi-Fi standards include 802.11be (Wi-Fi 7) , 802.11ax (Wi-Fi 6) , or Compatibility Mode . The final effective Wi-Fi standard depends on the support of Wi-Fi standards on each device. The latest standard is recommended. If there is a compatibility issue, try use an older standard. However, an old standard setting will affect the bandwidth.
Wireless Schedule	Specify the time periods during which Wi-Fi is enabled. After you set this parameter, users cannot connect to Wi-Fi in other periods.
VLAN	Set the VLAN to which the Wi-Fi signal belongs. You can choose from the available VLANs or click Add New VLAN , and go to the LAN Settings page to add a VLAN.
Hide SSID	Enabling the hide SSID function can prevent unauthorized user access to Wi-Fi, improving security. However, mobile phones or computers cannot find the SSID after this function is enabled. You must manually enter the correct name and password to connect to Wi-Fi. Record the current SSID before you enable this function.
Client Isolation	After you enable this parameter, clients associated with the Wi-Fi are isolated from one other, and end users connected to the same AP (in the same network segment) cannot access each other. This improves security.

Parameter	Description
Band Steering	After this function is enabled, 5G-capable clients select 5G Wi-Fi preferentially. You can enable this function only when Band is set to 2.4G + 5G .
XPress	After this function is enabled, the device sends game packets preferentially, providing more stable wireless network for games.
Layer-3 Roaming	After this function is enabled, clients keep their IP addresses unchanged when associating with the same Wi-Fi. This function improves the roaming experience of users in the cross-VLAN scenario.
802.11r	Enabling the 802.11r function can shorten the roaming handover time. The 802.11r function is supported only when Encryption is set to Security or 802.11x (Enterprise) . Once 802.11r is enabled, the encryption type can only be WPA2-PSK or WPA2-802.11x.
LimitSpeed	<p>After enabling Wi-Fi rate limiting, you can set the uplink and downlink rate limits for users.</p> <ul style="list-style-type: none"> ● Rate Limit Per User: The rate limit applies to all clients connected to the SSID. ● Rate Limit All Users: All clients connected to the SSID share the configured rate limit equally. The rate limit of each client changes dynamically with the number of clients connected to the SSID.

3.3 Configuring SSID and Wi-Fi Password

(1) Go to the page for configuration.

- Method 1: Choose **Network-Wide > Workspace > Wireless > Wi-Fi > Wi-Fi List**. Select the Wi-Fi network, and click **Edit**.
- Method 2: Choose **One-Device > Config > WLAN > Wi-Fi > Wi-Fi List**. Select the Wi-Fi network, and click **Edit**.

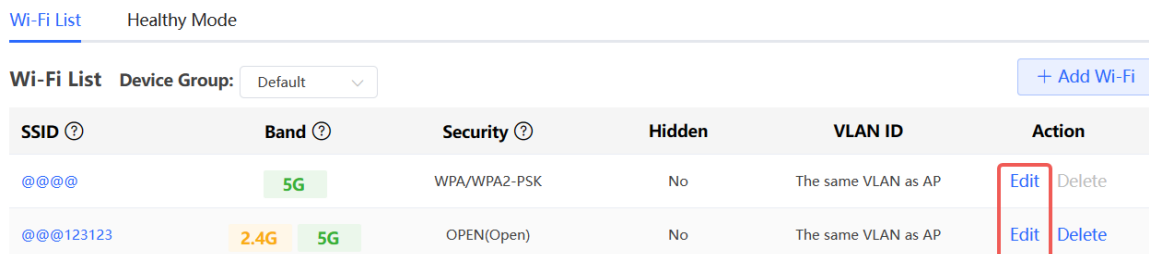

Up to 8 SSIDs can be added.

(2) Click the target Wi-Fi network, change the SSID and Wi-Fi password of the Wi-Fi network, and click **OK**.

⚠ Caution

After the configuration is saved, all online clients will be disconnected from the Wi-Fi network. You have to enter the new password to connect to the Wi-Fi network.

Edit

✕

* SSID ⓘ

Purpose ⓘ **General** | IoT | Guest

Band ⓘ 2.4G 5G

No available frequency band? Log in to Ruijie Cloud to add or re-identify the target frequency band. [Re-identify](#) [View Causes](#)

Encryption Open Security 802.1x (Enterprise) ⓘ

* Security ⓘ

* Wi-Fi Password

----- advanced Setting -----

Cancel

OK

3.4 Hiding the SSID

3.4.1 Overview

Hiding the SSID can prevent unauthorized clients from accessing the Wi-Fi network and enhance network security. After this function is enabled, the mobile phone or PC cannot search out the SSID. Instead, you have to manually enter the correct SSID and Wi-Fi password. Remember the SSID so that you can enter the correct SSID after the function is enabled.

3.4.2 Configuration Steps

(1) Go to the page for configuration.

- Method 1: Choose **Network-Wide > Workspace > Wireless > Wi-Fi > Wi-Fi List**. Select the Wi-Fi network, and click **Edit**.
- Method 2: Choose **One-Device > Config > WLAN > Wi-Fi > Wi-Fi List**. Select the Wi-Fi network, and click **Edit**.

Wi-Fi List Healthy Mode

Wi-Fi List Device Group: Default + Add Wi-Fi

SSID ?	Band ?	Security ?	Hidden	VLAN ID	Action
@@@	5G	WPA/WPA2-PSK	No	The same VLAN as AP	Edit Delete
@@@123123	2.4G 5G	OPEN(Open)	No	The same VLAN as AP	Edit Delete

Up to 8 SSIDs can be added.

(2) Click to expand advanced settings, turn on **Hide SSID** in the expanded settings and click **OK**.

Caution

After the configuration is saved, you have to manually enter the SSID and Wi-Fi password before connecting any device to the Wi-Fi network. Therefore, exercise caution when performing this operation.

----- advanced Setting -----

Wi-Fi Standard ? 802.11be(Wi-Fi7) ▼

Wireless Schedule ? All Time ▼

VLAN The same VLAN as AP ▼

Hide SSID (The SSID is hidden and must be manually entered.)

3.5 Checking Wireless Clients

If the self-organizing network is disabled, choose **Clients > Wireless**.

If the self-organizing network is enabled, in **Network-Wide** mode, choose **Clients > Wireless**.

Check information about all wireless clients connected to the Wi-Fi network. Click **Add to Blocklist** to disconnect a client and ban the client from accessing the Wi-Fi network.

All (0) Wired (0) **Wireless (0)** User not connected (0) ↻ Select Block

i The client going offline will not disappear immediately. Instead, the client will stay in the list for three more minutes.

Username	SSID and Band	Signal Quality	Connected To	IP/MAC	Negotiation Rate	Online Duration	LimitSpeed	Action
No Data								

Total 0 < 1 > 10/page ▼

Table 3-2 Wireless Client Configuration Parameters

Parameter	Description
Username	Name of a client.
SSID and Band	Name of the Wi-Fi network and the band.
Signal Quality	RSSI of the Wi-Fi network.
Connected To	SN of the device to which the client connects in wired or wireless mode.
IP/MAC	MAC address/IPv4 address of the client.
Negotiation Rate	Association rate of the client and AP.
Online Duration	Time when the client connects to the Wi-Fi network.
LimitSpeed	Association rate of the client and AP.

3.6 Configuring Wi-Fi Band

- (1) Go to the page for configuration.
 - Method 1: Choose **Network-Wide > Workspace > Wireless > Wi-Fi > Wi-Fi List**. Select the Wi-Fi network, and click **Edit**.
 - Method 2: Choose **One-Device > Config > WLAN > Wi-Fi > Wi-Fi List**. Select the Wi-Fi network, and click **Edit**.
- (2) Set the band of Wi-Fi signals. The device supports the 2.4 GHz and 5 GHz bands. Compared with the 2.4 GHz band, the 5 GHz band supports a higher network transmission rate and is less susceptible to interference, but is inferior in signal coverage and through-wall penetration. You can select an appropriate signal band based on actual requirements. The default Wi-Fi band is **2.4G+5G**, indicating that Wi-Fi signals are emitted in both 2.4 GHz and 5 GHz bands.

Edit

✕

* SSID ⓘ Purpose ⓘ **General** | IoT | GuestBand ⓘ 2.4G 5G

No available frequency band? Log in to Ruijie Cloud to add or re-identify the target frequency band. [Re-identify](#) [View Causes](#)

Encryption Open Security 802.1x (Enterprise) ⓘ* Security ⓘ

----- advanced Setting -----

Cancel

OK

3.7 Configuring Band Steering

Caution

This function can be enabled only after the dual-band integration (**Band** is set to **2.4G+5G**) is enabled on the Wi-Fi network. A client automatically selects a band only when the SSIDs of the 2.4 GHz and 5 GHz bands are the same.

(1) Go to the page for configuration.

- Method 1: Choose **Network-Wide > Workspace > Wireless > Wi-Fi > Wi-Fi List**. Select the Wi-Fi network, and click **Edit**.
- Method 2: Choose **One-Device > Config > WLAN > Wi-Fi > Wi-Fi List**. Select the Wi-Fi network, and click **Edit**.

(2) Click to expand advanced settings, turn on **Band Steering** in the expanded settings, and click **OK**. After the function is enabled, the client supporting 5 GHz selects the 5G Wi-Fi network preferentially.

Purpose ? **General** | IoT | Guest

Band ? 2.4G 5G

No available frequency band? Log in to Ruijie Cloud to add or re-identify the target frequency band. [Re-identify](#) [View Causes](#)

Encryption Open Security 802.1x (Enterprise) !

* Security ? ▼

----- advanced Setting -----

Wi-Fi Standard ? ▼

Wireless Schedule ? ▼

VLAN ▼

Hide SSID (The SSID is hidden and must be manually entered.)

Client Isolation ? (Prevent wireless clients of this Wi-Fi from communicating with one another.)

Band Steering (The 5G-supported client will access 5G radio preferentially.)

3.8 Configuring Wi-Fi 6

! Caution

The function takes effect only on APs supporting the IEEE 802.11ax protocol. In addition, access clients must support IEEE 802.11ax so that clients can enjoy high-speed Internet access experience brought by Wi-Fi 6. If clients do not support Wi-Fi 6, you can disable this function.

- (1) Go to the page for configuration.
 - Method 1: Choose **Network-Wide > Workspace > Wireless > Wi-Fi > Wi-Fi List**. Select the Wi-Fi network, and click **Edit**.
 - Method 2: Choose **One-Device > Config > WLAN > Wi-Fi > Wi-Fi List**. Select the Wi-Fi network, and click **Edit**.
- (2) Click **advanced Settings** to set the **Wi-Fi Standard** to **802.11ax(Wi-Fi6)**. Click **OK**. After this function is enabled, wireless clients can have faster network speed and optimized network experience.

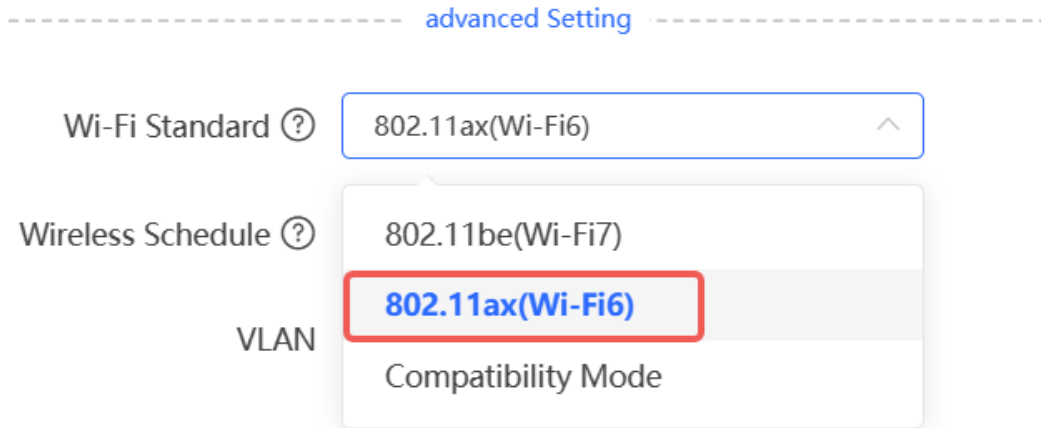

3.9 Configuring Wi-Fi 7

⚠ Caution

This configuration takes effect only on APs that support the IEEE 802.11be protocol. Clients also need to support the IEEE 802.11be protocol in order to experience high-speed Internet access brought by Wi-Fi 7. Disable this feature if the client does not support Wi-Fi 7.

- (1) Go to the page for configuration.
 - Method 1: Choose **Network-Wide > Workspace > Wireless > Wi-Fi > Wi-Fi List**. Select the Wi-Fi network, and click **Edit**.
 - Method 2: Choose **One-Device > Config > WLAN > Wi-Fi > Wi-Fi List**. Select the Wi-Fi network, and click **Edit**.
- (2) Click **advanced Settings** to set the **Wi-Fi Standard** to **802.11be(Wi-Fi7)**. Click **OK**. After this function is enabled, wireless clients can have faster network speed and optimized network experience.

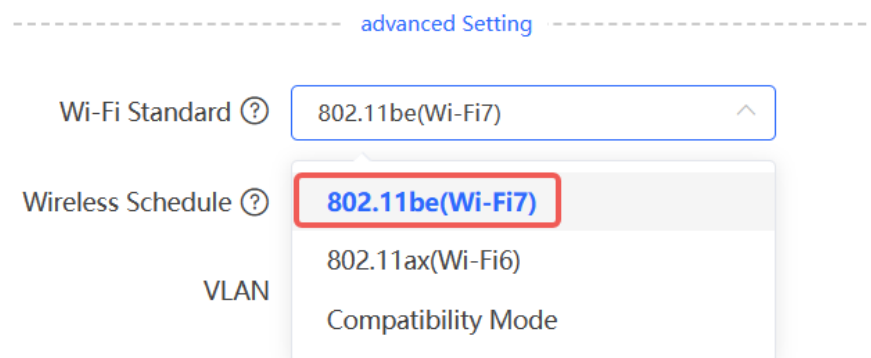

3.10 Configuring Layer-3 Roaming

- (1) Go to the page for configuration.
 - Method 1: Choose **Network-Wide > Workspace > Wireless > Wi-Fi > Wi-Fi List**. Select the Wi-Fi network,

and click **Edit**.

- Method 2: Choose **One-Device > Config > WLAN > Wi-Fi > Wi-Fi List**. Select the Wi-Fi network, and click **Edit**.
- (2) Click to expand advanced settings, turn on **Layer 3 Roaming** in the expanded settings and click **OK**. The client will keep the IP address unchanged in this Wi-Fi network, improving roaming experience across VLANs.

Band Steering (The 5G-supported client will access 5G radio preferentially.)

XPress (The client will experience faster speed.)

Layer 3 Roaming (The client will keep the IP address unchanged on the Wi-Fi network.)

[Do you want to edit RF parameters? Navigate to Radio Frequency for configuration.](#)

Cancel

3.11 Configuring Client Isolation

- (1) Go to the page for configuration.
- Method 1: Choose **Network-Wide > Workspace > Wireless > Wi-Fi > Wi-Fi List**. Select the Wi-Fi network, and click **Edit**.
 - Method 2: Choose **One-Device > Config > WLAN > Wi-Fi > Wi-Fi List**. Select the Wi-Fi network, and click **Edit**.
- (2) Click to expand advanced settings, turn on **Client Isolation** in the expanded settings and click **Save**. The clients joining in this Wi-Fi network will be isolated. The clients associated with the same access point cannot access each other.

Wi-Fi Standard

Wireless Schedule

VLAN

Hide SSID (The SSID is hidden and must be manually entered.)

Client Isolation (Prevent wireless clients of this Wi-Fi from communicating with one another.)

3.12 Configuring 802.11r

The **802.11r** function is available only when the Encryption is set to **Security** or **802.1x(Enterprise)**. Once **802.11r** is enabled, **Security** can only be set to WPA2-PSK or WPA2-802.1X.

(1) Go to the page for configuration.

- Method 1: Choose **Network-Wide > Workspace > Wireless > Wi-Fi > Wi-Fi List**. Select the Wi-Fi network, and click **Edit**.
- Method 2: Choose **One-Device > Config > WLAN > Wi-Fi > Wi-Fi List**. Select the Wi-Fi network, and click **Edit**.

(2) Click **advanced Settings**. Enable **802.11r**, and click OK.

XPress (The client will experience faster speed.)

Layer 3 Roaming (The client will keep the IP address unchanged on the Wi-Fi network.)

802.11r (After this feature is enabled, roaming time is reduced to achieve fast transition.)

LimitSpeed

[Do you want to edit RF parameters? Navigate to Radio Frequency for configuration.](#)

Cancel

OK

3.13 Configuring a Guest Wi-Fi

3.13.1 Overview

This Wi-Fi network is provided for guests and is disabled by default. It supports client isolation, that is, access clients are isolated from each other. They can only access the Internet via Wi-Fi, but cannot access each other, improving security. The guest Wi-Fi network can be turned off as scheduled. When the time expires, the guest network is off.

3.13.2 Configuration Steps

- Method 1: Choose **Network-Wide > Workspace > Wireless > Wi-Fi > Wi-Fi List**.
- Method 2: Choose **One-Device > Config > WLAN > Wi-Fi > Wi-Fi List**.

Click **Add Wi-Fi**. Set the purpose to **Guest** and configure the SSID and password. Click **advanced Settings** to configure the effective time of the guest Wi-Fi and other Wi-Fi parameters. After the settings are saved, guests can connect to the Internet through the set SSID and password.

Add
×

* SSID ?

Purpose ? General | IoT | Guest

Band ? 2.4G 5G

No available frequency band? Log in to Ruijie Cloud to add or re-identify the target frequency band. [Re-identify](#) [View Causes](#)

Encryption Open Security 802.1x (Enterprise) !

* Security ?

* Wi-Fi Password 🔍

----- advanced Setting -----

3.14 Configuring Wireless Rate Limiting

3.14.1 Overview

The device supports four rate limiting modes: client-based rate limiting, SSID-based rate limiting, AP-based rate limiting, and packet-based rate limiting. For the same client, if multiple rate limiting modes are configured, the priority order is as follows: client-based rate limiting > SSID-based rate limiting > AP-based rate limiting > packet-based rate limiting.

- Client-based rate limiting: This function allows you to limit the rate based on the MAC address of the client, so as to limit or guarantee the bandwidth required by specific clients.
- SSID-based rate limiting: This function provides two rate limiting modes for a specified SSID: **Rate Limit Per User** and **Rate Limit All Users**. **Rate Limit Per User** means that all clients connected to the SSID use the same rate limit. **Rate Limit All Users** means that the configured rate limit value is evenly allocated to all clients connected to the SSID. The rate limit value of each client dynamically changes with the number of clients connected to the SSID.
- AP-based rate limiting: This function limits the client rates based on the whole network. All clients connected to the network will work according to the configured rate limit value.
- Packet-based rate limiting: This function limits the client rates based on the downlink broadcast and multicast packets. The device supports rate limiting for specific broadcast packets (such as ARP and DHCP), multicast packets (such as MDNS and SSDP), or all types of broadcast and multicast packets. If network stalling remains during network access and there is no client with large traffic, you are advised to adjust the rate between 1 kbps and 512 kbps.

3.14.2 Configuration Steps

1. Configuring Client-based Rate Limiting

Choose **Network-Wide > Workspace > Wireless > Rate Limiting > Client-based Rate Limiting**.

(1) Enable **Wireless Rate Limiting**.

Wireless Rate Limiting

[Client-based Rate Limiting](#) SSID-based Rate Limiting AP-based Rate Limiting Packet-based Rate Limiting

i The rate limiting mode based on wireless clients can limit or provide the bandwidth for specific clients.

Client-based Rate Limiting + Add Delete Selected

<input type="checkbox"/>	Client MAC	Uplink Rate Limit	Downlink Rate Limit	Remarks	Action
No Data					

Up to 512 entries can be added. Total 0 < 1 > 10/page

(2) Click **Add**. In the dialog box that appears, set the MAC address and uplink and downlink rate limit values of the client, and click **OK**.

Wireless Rate Limiting

[Client-based Rate Limiting](#) SSID-based Rate Limiting AP-based Rate Limiting Packet-based Rate Limiting

i The rate limiting mode based on wireless clients can limit or provide the bandwidth for specific clients.

Client-based Rate Limiting + Add Delete Selected

<input type="checkbox"/>	Client MAC	Uplink Rate Limit	Downlink Rate Limit	Remarks	Action
No Data					

Up to 512 entries can be added. Total 0 < 1 > 10/page

Add ×

* Client MAC

Uplink Rate
Limit Current: Kbps. Range: 1-1700000 Kbps

Downlink Rate
Limit Current: Kbps. Range: 1-1700000 Kbps

Remarks

2. Configuring SSID-based Rate Limiting

Method 1: Choose **Network-Wide > Workspace > Wireless > Rate Limiting > SSID-based Rate Limiting**.

- (1) Enable **Wireless Rate Limiting**.
- (2) Click **Edit** in the **Action** column of the target SSID. In the dialog box that appears, set the uplink and downlink rate limit modes and values, and click **OK**.

Wireless Rate Limiting

Client-based Rate Limiting SSID-based Rate Limiting AP-based Rate Limiting Packet-based Rate Limiting

i This function provides rate limit per user and dynamic rate limiting for a specified SSID. Rate Limit per User indicates that all clients connected to the SSID use the same rate limit. Rate Limit All Users indicates that all clients connected to the SSID share the rate limit in average. The priority of this function is lower than that of client-based rate limiting.

SSID-based Rate Limiting Device Group: [Are you sure you want to add a Wi-Fi? Click to go.](#)

SSID	Uplink Rate Limit	Downlink Rate Limit	Action
@@@@	No Limit	No Limit	Edit Disable

Edit ×

Uplink Rate Limit (?) Rate Limit Per User Rate Limit All Users

Rate Limit

Current: Kbps. Range: 1-1700000 Kbps

Downlink Rate Limit (?) Rate Limit Per User Rate Limit All Users

Rate Limit

Current: Kbps. Range: 1-1700000 Kbps

Method 2:

- (1) Go to the configuration page:
 - Method 1: Choose **Network-Wide > Workspace > Wireless > Wi-Fi > Wi-Fi List**. Select the Wi-Fi network, and click **Edit**.
 - Method 2: Choose **One-Device > Config > WLAN > Wi-Fi > Wi-Fi List**. Select the Wi-Fi network, and click **Edit**.
- (2) Click to expand advanced settings. Enable **LimitSpeed**, set the uplink and downlink rate limit modes and rate limits, and click **OK**.

LimitSpeed

Uplink Rate Limit ? Rate Limit Per User Rate Limit All Users

Rate Limit

Current: Kbps. Range: 1-1700000 Kbps

Downlink Rate Limit ? Rate Limit Per User Rate Limit All Users

Rate Limit

Current: Kbps. Range: 1-1700000 Kbps

[Do you want to edit RF parameters? Navigate to Radio Frequency for configuration.](#)

3. Configuring AP-based Rate Limiting

Choose **Network-Wide > Workspace > Wireless > Rate Limiting > AP-based Rate Limiting**.

- (1) Enable **Wireless Rate Limiting**.
- (2) Set the uplink and downlink rate limit modes to **Rate Limit Per User**, configure the rate limit values, and click **OK**.

Wireless Rate Limiting

[Client-based Rate Limiting](#) [SSID-based Rate Limiting](#) [AP-based Rate Limiting](#) [Packet-based Rate Limiting](#)

i This function provides client rate limiting based on the whole network. All devices connected to the network use the preset rate limiting value. The priority of this function is lower than that of client-based rate limiting and SSID-based rate limit per user.

AP-based Rate Limiting

Uplink Rate Limit ? No Limit Rate Limit Per User

Current: Kbps. Range: 1-1700000 Kbps

Downlink Rate Limit No Limit Rate Limit Per User

Current: Kbps. Range: 1-1700000 Kbps

4. Configuring Packet-based Rate Limiting

Choose **Network-Wide > Workspace > Wireless > Rate Limiting > Packet-based Rate Limiting**.

- (1) Enable **Wireless Rate Limiting**.
- (2) Select the specific type of packets for rate limiting, configure the rate limit value, and click **Save**.

Wireless Rate Limiting

Client-based Rate Limiting [SSID-based Rate Limiting](#) AP-based Rate Limiting [Packet-based Rate Limiting](#)

This function allows users to limit the downlink rate for broadcast and multicast packets. If the internet access is still slow and unstable when no client needs large amounts of traffic, you are advised to set the rate ranging from 1 Kbps to 512 Kbps. Smaller rate brings better network improvement.
Tip: A lower rate limit brings better network improvement but may affect client services. A higher rate limit indicates poorer network improvement.

Packet-based Rate Limiting

Broadcast Rate Limiting Disable Limit All Limit Part

ARP Packet DHCP Packet

Multicast Rate Limiting Disable Limit All Limit Part

MDNS Packet SSDP Packet

* Rate Limit Kbps

Current: 0 Kbps. Range: 1-1700000 Kbps

3.15 Configuring Wi-Fi Blocklist or Allowlist

3.15.1 Overview

You can configure the global or SSID-based blocklist and allowlist. The MAC address supports full match and OUI match.

Wi-Fi blocklist: Clients in the Wi-Fi blocklist are prevented from accessing the Internet. Clients that are not added to the Wi-Fi blocklist are free to access the Internet.

Wi-Fi allowlist: Only clients in the Wi-Fi allowlist can access the Internet. Clients that are not added to the Wi-Fi allowlist are prevented from accessing the Internet.

 **Caution**

If the allowlist is empty, the allowlist does not take effect. In this case, all clients are allowed to access the Internet.

3.15.2 Configuration Steps

1. Configuring a Global Blocklist/Allowlist

Choose **Network-Wide > Workspace > Wireless > Blocklist and Allowlist > Global Blocklist/Allowlist**.

Select the blocklist or allowlist mode and click **Add** to configure a blocklist or allowlist client. Enter the device name, match type, and MAC address of the client to be added to the blacklist or whitelist in the displayed dialog box, and click **OK**. If a client is already associated with the access point, its MAC address will pop up automatically. Click the MAC address directly for automatic input. All clients in the blocklist will be forced offline

and not allowed to access the Wi-Fi network. The global blocklist and allowlist settings take effect on all Wi-Fi networks of the access point.

Global Blocklist/Allowlist SSID-Based Blocklist/Allowlist

All STAs except blocklisted STAs are allowed to access Wi-Fi.
 Only the allowlisted STAs are allowed to access Wi-Fi.

Blocked WLAN Clients + Add Delete Selected

<input type="checkbox"/>	Device Name	MAC Address	Action
No Data			

Up to 512 members can be added. Total 0 1 10/page

Add ×

Device Name ?

Match Type Full Prefix (OUI)

* MAC Address

2. Configuring an SSID-based Blocklist/Allowlist

Choose **Network-Wide > Workspace > Wireless > Blocklist and Allowlist > SSID-Based Blocklist/Allowlist**. Select a target Wi-Fi network from the left column, select the blocklist or allowlist mode and click **Add** to configure a blocklist or allowlist client. The SSID-based blocklist and allowlist will restrict the client access to the specified Wi-Fi.

Global Blocklist/Allowlist SSID-Based Blocklist/Allowlist

Blocklist/Allowlist is used to allow or reject a client's request to connect to the Wi-Fi network.
Note: OUI matching rule and SSID-based blocklist/allowlist are supported by only RAP Net and P32 (and later versions).
Rule: 1. In the Blocklist mode, the clients in the blocklist are not allowed to connect to the Wi-Fi network.
 2. In the Allowlist mode, only the clients in the allowlist are allowed to connect to the Wi-Fi network.

Device Group: Default

SSID-Based Blocklist/Allowlist

@@@@

All STAs except blocklisted STAs are allowed to access Wi-Fi.
 Only the allowlisted STAs are allowed to access Wi-Fi.

Blocked WLAN Clients + Add Delete Selected

<input type="checkbox"/>	Device Name	MAC Address	Action
No Data			

Up to 512 members can be added. Total 0 < 1 > 10/page

3.16 Optimizing Wi-Fi Network

3.16.1 Overview

The device detects the surrounding wireless environment and selects the appropriate configuration upon power-on. However, network stalling caused by wireless environment changes cannot be avoided. You can optimize the network with one single click, analyze the wireless environment around the access point and select appropriate parameters.

⚠ Caution

After being optimized, the Wi-Fi network will restart, and clients need to reconnect to the W-Fi network. Therefore, exercise caution when performing this operation.

3.16.2 Getting Started

Install Wi-Fi Moho or other Wi-Fi scanning app on the mobile phone and check interference analysis results to find out the best channel.

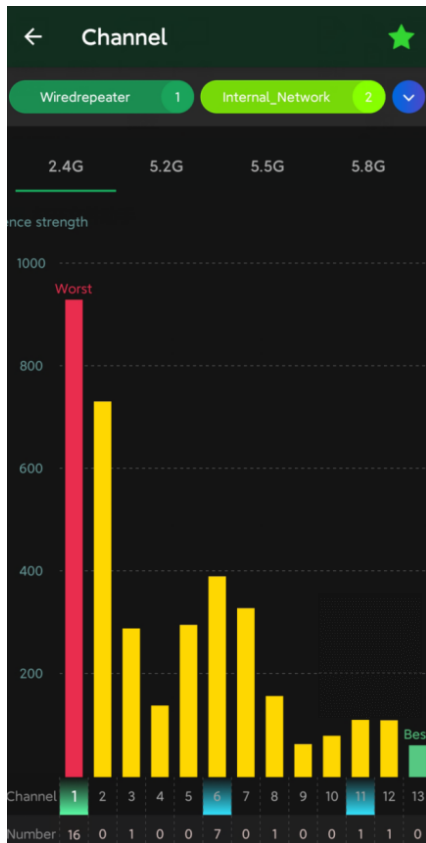

3.16.3 Optimizing the Radio Channel

- Configure the master device. Choose **Network-Wide > Workspace > Wireless > Radio Setting**.
- Configure the slave device. Choose **Network-Wide > Devices**. Click **Manage** in the **Action** column of the corresponding device. Then, choose **Config > WLAN > Radio Setting**.

Choose the best channel identified by Wi-Fi Moho or other Wi-Fi scanning App. Click **Save** to make the configuration take effect immediately. The more devices in a channel, the greater the interference.

Note

The available channel is related to the country or region code. Select the local country or region.

Radio Setting

Common Parameter No available frequency band? Log in to Ruijie Cloud to add or re-identify the target frequency band. [Re-identify](#) [View Causes](#)

Country/Region China (CN)

Radio Parameters

Global Radio Settings

Channel Width 20MHz

Multicast Rate (Mbps) Auto

Client Count Limit 32

Disconnection Threshold Disable -85dBm -65dBm

Standalone Radio Settings

Channel Auto

Transmit Power Auto Lower Low Medium High

Roaming Low 40% 80% High

Access Threshold Disable -85dBm -65dBm

Response RSSI Threshold Disable -85dBm -65dBm

[Save](#)

3.16.4 Optimizing the Channel Width

Choose **Network-Wide > Workspace > Wireless > Radio Setting**.

A network with a lower channel width is more stable, while a network with a higher channel width is susceptible to interference. If the interference is severe, choose a lower channel width to avoid network stalling to a certain extent. The access point supports the channel width of 20 MHz and 40 MHz in the 2.4 GHz channel, and the channel width of 20 MHz and 40 MHz and 80 MHz and 160 MHz in the 5 GHz channel.

The default value is **Auto**, indicating that the channel width is automatically selected based on the environment. After changing the channel width, click **Save** to make the configuration take effect immediately.

⚠ Caution

In the self-organizing network mode, the channel width settings will be synchronized to all devices in the network.

Radio Setting Device Group: Default Not solved yet? [Click here to access the Network Optimization page for automatic optimization.](#)

Radio Parameters No available frequency band? Log in to Ruijie Cloud to add or re-identify the target frequency band. [Re-identify](#) [View Causes](#)

Country/Region China (CN)

Radio Parameters

Global Radio Settings

Channel Width Auto

Multicast Rate (Mbps) Auto

Client Count Limit 64

Disconnection Threshold Disable -85dBm -65dBm

Standalone Radio Settings

Channel Auto

Transmit Power Auto Lower Low Medium High

Roaming Low 40% 80% High

Access Threshold Disable -85dBm -65dBm

Response RSSI Threshold Disable -85dBm -65dBm

[Save](#)

3.16.5 Optimizing the Transmit Power

- Configure the master device. Choose **Network-Wide > Workspace > Wireless > Radio Setting**.
- Configure the slave device. Choose **Network-Wide > Devices**. Click **Manage** in the **Action** column of the corresponding device. Then, choose **Config > WLAN > Radio Setting**.

A greater transmit power indicates a larger coverage and brings stronger interference to surrounding wireless routers. In a high-density scenario, you are advised to set the transmit power to a small value. The **Auto** mode is recommended, indicating automatic adjustment of the transmit power. After adjusting the configuration, click **Save**.

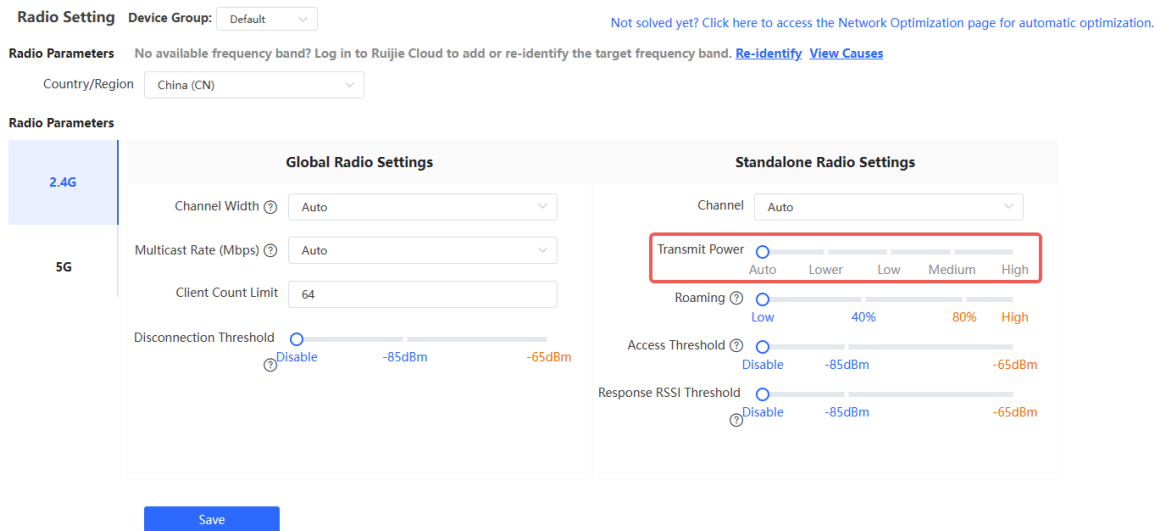

3.16.6 Configuring the Multicast Rate

Choose **Network-Wide > Workspace > Wireless > Radio Setting**.

If the multicast rate is too high, the packet loss rate of multicast packets may increase. If the multicast rate is too low, the radio interface may become busy. When network stalling is serious, you are advised to configure a high multicast rate. When network stalling is minor, configure a medium multicast rate. After adjusting the configuration, click **Save**.

Radio Setting Device Group: Default [Not solved yet? Click here to access the Network Optimization page for automatic optimization.](#)

Radio Parameters No available frequency band? Log in to Ruijie Cloud to add or re-identify the target frequency band. [Re-identify](#) [View Causes](#)

Country/Region China (CN)

Radio Parameters

2.4G

5G

Global Radio Settings

Channel Width ? Auto

Multicast Rate (Mbps) ? Auto

Client Count Limit 64

Disconnection Threshold ? Disable -85dBm -65dBm

Standalone Radio Settings

Channel Auto

Transmit Power ? Auto Lower Low Medium High

Roaming ? Low 40% 80% High

Access Threshold ? Disable -85dBm -65dBm

Response RSSI Threshold ? Disable -85dBm -65dBm

Save

3.16.7 Configuring the Client Limit

Choose **Network-Wide > Workspace > Wireless > Radio Setting**.

If the access point is associated with too many clients, it will have a lower performance, affecting user experience. After you configure the threshold, new clients over the threshold will not be allowed to access the Wi-Fi network. You can lower the threshold if there is requirement for bandwidth per client. You are advised to keep the default settings unless there are special cases. After adjusting the configuration, click **Save**.

Radio Setting Device Group: Default [Not solved yet? Click here to access the Network Optimization page for automatic optimization.](#)

Radio Parameters No available frequency band? Log in to Ruijie Cloud to add or re-identify the target frequency band. [Re-identify](#) [View Causes](#)

Country/Region China (CN)

Radio Parameters

2.4G

5G

Global Radio Settings

Channel Width ? Auto

Multicast Rate (Mbps) ? Auto

Client Count Limit 64

Disconnection Threshold ? Disable -85dBm -65dBm

Standalone Radio Settings

Channel Auto

Transmit Power ? Auto Lower Low Medium High

Roaming ? Low 40% 80% High

Access Threshold ? Disable -85dBm -65dBm

Response RSSI Threshold ? Disable -85dBm -65dBm

Save

Note

The **Client Count Limit** refers to the maximum number of clients that can be connected to a single access point.

3.16.8 Configuring the Kick-off Threshold

Choose **Network-Wide > Workspace > Wireless > Radio Setting**.

In the case of multiple Wi-Fi signals, setting the kick-off threshold can improve the wireless signal quality to a certain extent. The farther the client is away from the access point, the lower the signal strength is. If the signal is lower than the kick-off threshold, the Wi-Fi will be disconnected, and the client will be forced offline and select a nearer Wi-Fi signal.

However, the higher the kick-off threshold is, the easier it is for the client to be kicked offline. To ensure normal Internet access, you are advised to disable the kick-off threshold or set the value to less than -75dBm. After adjusting the configuration, click **Save**.

Radio Setting Device Group: Default Not solved yet? [Click here to access the Network Optimization page for automatic optimization.](#)

Radio Parameters No available frequency band? [Log in to Ruijie Cloud to add or re-identify the target frequency band.](#) [Re-identify](#) [View Causes](#)

Country/Region China (CN)

Radio Parameters

	Global Radio Settings	Standalone Radio Settings
2.4G	Channel Width ? Auto	Channel ? Auto
	Multicast Rate (Mbps) ? Auto	Transmit Power ? Auto Lower Low Medium High
5G	Client Count Limit ? 64	Roaming ? Low 40% 80% High
	Disconnection Threshold ? Disable -85dBm -65dBm	Access Threshold ? Disable -85dBm -65dBm
		Response RSSI Threshold ? Disable -85dBm -65dBm

Save

Caution

In the self-organizing network mode, the kick-off threshold settings will be synchronized to all devices in the network.

3.16.9 Configuring the Roaming Sensitivity

- Configure the master device. Choose **Network-Wide > Workspace > Wireless > Radio Setting**.
- Configure the slave device. Choose **Network-Wide > Devices**. Click **Manage** in the **Action** column of the corresponding device. Then, choose **Config > WLAN > Radio Setting**.

The roaming sensitivity enables the device to actively disconnect a client from the Wi-Fi network when the client is far away, forcing the client to re-select the nearest signal and thus improving the sensitivity of wireless roaming. Higher the roaming sensitivity level, smaller the wireless signal coverage. To improve the signal quality for a client moving within more than one Wi-Fi coverage, improve the roaming sensitivity level. You are advised to keep the default settings. After adjusting the configuration, click **Save**.

Radio Setting Device Group: Default [Not solved yet? Click here to access the Network Optimization page for automatic optimization.](#)

Radio Parameters No available frequency band? Log in to Ruijie Cloud to add or re-identify the target frequency band. [Re-identify](#) [View Causes](#)

Country/Region China (CN)

Radio Parameters

2.4G

5G

Global Radio Settings

Channel Width ? Auto

Multicast Rate (Mbps) ? Auto

Client Count Limit 64

Disconnection Threshold ? Disable -85dBm -65dBm

Standalone Radio Settings

Channel Auto

Transmit Power ? Auto Lower Low Medium High

Roaming ? Low 40% 80% High

Access Threshold ? Disable -85dBm -65dBm

Response RSSI Threshold ? Disable -85dBm -65dBm

Save

3.16.10 Configuring Access Threshold

- Configure the master device. Choose **Network-Wide > Workspace > Wireless > Radio Setting**.
- Configure the slave device. Choose **Network-Wide > Devices**. Click **Manage** in the **Action** column of the corresponding device. Then, choose **Config > WLAN > Radio Setting**.

When the wireless signal of the end user is lower than the access threshold set on the device, the client cannot detect the wireless signal of the device. After adjusting the configuration, click **Save**.

Radio Setting Device Group: Default [Not solved yet? Click here to access the Network Optimization page for automatic optimization.](#)

Radio Parameters No available frequency band? Log in to Ruijie Cloud to add or re-identify the target frequency band. [Re-identify](#) [View Causes](#)

Country/Region China (CN)

Radio Parameters

2.4G

5G

Global Radio Settings

Channel Width ? Auto

Multicast Rate (Mbps) ? Auto

Client Count Limit 64

Disconnection Threshold ? Disable -85dBm -65dBm

Standalone Radio Settings

Channel Auto

Transmit Power ? Auto Lower Low Medium High

Roaming ? Low 40% 80% High

Access Threshold ? Disable -85dBm -65dBm

Response RSSI Threshold ? Disable -85dBm -65dBm

Save

3.16.11 Configuring Response RSSI Threshold

- Configure the master device. Choose **Network-Wide > Workspace > Wireless > Radio Setting**.
- Configure the slave device. Choose **Network-Wide > Devices**. Click **Manage** in the **Action** column of the corresponding device. Then, choose **Config > WLAN > Radio Setting**.

When the wireless signal of the end user is lower than the response RSSI threshold configured on the device, the client cannot detect the wireless signal of the device. The smaller the response RSSI threshold is configured,

the less the environmental factors interfere with the AP. However, the connection of the client may be affected. After adjusting the configuration, click **Save**.

Radio Setting Device Group: Default Not solved yet? [Click here to access the Network Optimization page for automatic optimization.](#)

Radio Parameters No available frequency band? Log in to Ruijie Cloud to add or re-identify the target frequency band. [Re-identify](#) [View Causes](#)

Country/Region China (CN)

Radio Parameters

	Global Radio Settings	Standalone Radio Settings
2.4G	Channel Width ⓘ Auto	Channel Auto
5G	Multicast Rate (Mbps) ⓘ Auto	Transmit Power Auto Lower Low Medium High
	Client Count Limit 64	Roaming ⓘ Low 40% 80% High
	Disconnection Threshold ⓘ Disable -85dBm -65dBm	Access Threshold ⓘ Disable -85dBm -65dBm
		Response RSSI Threshold ⓘ Disable -85dBm -65dBm

Save

3.16.12 Configuring WIO

Choose **Network-Wide > Workspace > WLAN Optimization**.

Select the optimization mode. Then, click **OK** to optimize the wireless network.

⚠ Caution

- WIO is supported only in the self-organizing network mode.
- The client may be offline during the optimization process. The configuration cannot be rolled back once optimization starts. Therefore, exercise caution when performing this operation.

Table 3-3 Description of Tuning Mode

Parameter	Description
Quick tuning	In this mode, external interference and bandwidth are not considered. A quick optimization is performed to optimize channel, power, and management frame power.

Parameter	Description
Deep tuning	<p>In this mode, external interference and bandwidth are considered. A deep optimization is performed to optimize channel, power, and management frame power. Click to expand Advanced Settings to configure the scanning time, channel bandwidth and channels.</p> <ul style="list-style-type: none"> ● Scanning time: Indicates the time for scanning channels during the optimization. ● Roaming Sensitivity: The roam sensitivity can be optimized based on the actual environment to ensure fast roaming of wireless devices. ● Transmit power: Increasing the transmit power enhances both the strength and coverage of the wireless signal, but it may also introduce interference to surrounding wireless networks. With this feature enabled, the AP will automatically adjust the transmit power based on the environment. ● 2.4G <ul style="list-style-type: none"> ○ Channel bandwidth: Indicates the channel bandwidth. The channel bandwidth will be calculated by the system if Default is selected. ○ Selected channels: Indicates the channels to be optimized. ● 5G <ul style="list-style-type: none"> ○ Channel bandwidth: Indicates the channel bandwidth. The channel bandwidth will be calculated by the system if Default is selected. ○ Selected channels: Indicates the channels to be optimized.

- Choose **Quick optimization**, and click **OK**.

[Network Optimization](#)
 [Scheduled Optimization](#)
 [Optimization Record](#)
 [802.11k/v Roaming Optimization](#)
 [Advanced](#)



Wireless Intelligent Optimization

In a networking environment, WIO can help maximize wireless performance by optimizing your network.

Optimization

Optimization Quick optimization Deep optimization mode

Estimated Time

180s Environment scan + 3 minute Optimization

Instructions

- Upgrade all APs to the latest version for optimal network optimization.
- WIO is not supported on APs without an IP address.
- WIO only supports 20 MHz, 40 MHz, and 80 MHz channel bandwidths at the moment.
- Please perform optimization after all APs in the target area are online.

OK

- Choose **Deep optimization**. Click to expand **Advanced Settings** to set the scanning time, channel bandwidth and selected channels. Then, click **OK**.

Wireless Intelligent Optimization

In a networking environment, WIO can help maximize wireless performance by optimizing your network.

Optimization

Optimization Quick optimization Deep optimization mode

----- [Advanced Settings](#) -----

Scan time

Roaming

Sensitivity

Transmit Power



2.4G

Channel Width: Default

* Selected channels:

1 (2.412GHz)	2 (2.417GHz)
3 (2.422GHz)	4 (2.427GHz)
5 (2.432GHz)	6 (2.437GHz)
7 (2.442GHz)	8 (2.447GHz)
9 (2.452GHz)	10 (2.457GHz)
11 (2.462GHz)	12 (2.467GHz)
13 (2.472GHz)	

5G

Channel Width: Default

* Selected channels:

36 (5.180GHz)	40 (5.200GHz)
44 (5.220GHz)	48 (5.240GHz)
52 (5.260GHz) (Radar channel)	
56 (5.280GHz) (Radar channel)	
60 (5.300GHz) (Radar channel)	
64 (5.320GHz) (Radar channel)	
149 (5.745GHz)	153 (5.765GHz)
157 (5.785GHz)	161 (5.805GHz)
165 (5.825GHz)	

Estimated Time

550s
Environment scan

+

5 minute
Optimization

Instructions

- Upgrade all APs to the latest version for optimal network optimization.
- WIO is not supported on APs without an IP address.
- WIO only supports 20 MHz, 40 MHz, and 80 MHz channel bandwidths at the moment.
- Please perform optimization after all APs in the target area are online.

OK

After the optimization starts, please be patient and wait for the optimization to complete. After optimization is completed, you can click **Cancel Optimization** to restore the optimized RF parameters to their default values. Click **Back to Home** to perform wireless optimization again.

[Network Optimization](#)
[Scheduled Optimization](#)
[Optimization Record](#)
[802.11k/v Roaming Optimization](#)
[Advanced](#)



Finish

Completion time: 2023-12-11 17:03:59
 Optimization mode Quick optimization
 Time consumed: 47 seconds. Optimized 3 APs, resolved severe interference of 3 APs, reduced channel interference by 0.00%, and improved user experience by 0.00%.

[Cancel Optimization](#)

[Back to Home](#)

Optimization Details

5G
2.4G

Hostname	Band	SN	Channel Width (Before/After)	Channel (Before/After)	Transmit Power (Before/After)	Sensitivity (Before/After)
Ruijie	5G	G1RP6ZD230980	20->80	40->36	auto->100	0->20
Ruijie	5G	G1QH4PE000917	20->80	64->36	auto->100	0->20
Ruijie	5G	G1SK7N7000748	20->80	56->36	auto->100	0->20

Total 3 1 10/page

Click **Optimization Record** to view the details of the latest optimization.

Network Optimization Scheduled Optimization **Optimization Record** 802.11k/v Roaming Optimization Advanced

i Last Optimized:2023-12-11 17:03:59
Time consumed: 47 seconds. Optimized 3 APs, resolved severe interference of 3 APs, reduced channel interference by 0.00%, and improved user experience by 0.00%.

Optimization Details Enter AP name/SN 5G 2.4G

Hostname	Band	SN	Channel Width (Before/After)	Channel (Before/After)	Transmit Power (Before/After)	Sensitivity (Before/After)
Ruijie	5G	G1RP6ZD230980	20->80	40->36	auto->100	0->20
Ruijie	5G	G1QH4PE000917	20->80	64->36	auto->100	0->20
Ruijie	5G	G1SK7N7000748	20->80	56->36	auto->100	0->20

Total 3 < 1 > 10/page

You are advised to set a scheduled task to optimize the wireless network in the early hours of the morning or when the network is idle.

Network Optimization **Scheduled Optimization** Optimization Record 802.11k/v Roaming Optimization Advanced

i Optimize the network performance at a scheduled time for a better user experience.

Enable

Day Wed

Time 05 : 13

Schedule Weekly One time

Optimization mode Quick optimization Deep optimization

Save

3.16.13 Configuring Wi-Fi Roaming Optimization (802.11k/v)

Choose **Network-Wide > Workspace > WLAN Optimization > 802.11k/v Roaming Optimization**.

Choose the optimization mode. Click **Enable** and the Wi-Fi roaming is further optimized through the 802.11k/v protocol. Smart clients compliant with 802.11k/v can switch to the APs with better signal and faster speed during the roaming process, ensuring high-speed wireless connectivity. To ensure smart roaming effect, the WLAN environment will be auto scanned when Wi-Fi roaming optimization is first enabled.

⚠ Caution

- WIO is supported only in the self-organizing network mode.
- During the WLAN environment scanning, the APs will switch channels, forcing the clients to go offline. The process will last for 2 minutes.

Network Optimization Scheduled Optimization Optimization Record **802.11k/v Roaming Optimization** Advanced

Start ————— Scanning ————— Optimizing ————— Finish

Description:

The Wi-Fi roaming is further optimized through the 802.11k/v protocol. Smart clients compliant with 802.11k/v can switch to the APs with better signal and faster speed during the roaming process, ensuring high-speed wireless connectivity.

To ensure smart roaming effect, the WLAN environment will be auto scanned when Wi-Fi roaming optimization is first enabled.

Notes:

During the WLAN environment scanning, the APs will switch channels, forcing the clients to go offline. The process will last for 2 minutes.

Optimization Mode ? Performance-prior Roaming-prior

Enable

Table 3-4 Optimization Mode

Parameter	Description
Performance-prior	Maximum negotiation speed is preferentially guaranteed but connection stability may be affected.
Roaming-prior	Connection stability is preferentially guaranteed but maximum negotiation speed may be reduced.

Network Optimization Scheduled Optimization Optimization Record **802.11k/v Roaming Optimization** Advanced

Start ————— Scanning ————— Optimizing ————— Finish

802.11k/v Roaming Optimization Scanning

20%

Start: 2023-12-11 17:33:34
Expected Time: 2 minute

Network Optimization Scheduled Optimization Optimization Record **802.11k/v Roaming Optimization** Advanced

Start ————— Scanning ————— Optimizing ————— Finish

Optimization is enabled.

Optimization finished on 2023-12-11 17:34:06
Time: 32 seconds
To ensure smart roaming effect, please [Click Here](#) to scan the WLAN environment again if the topology changes.

Disable

3.17 Configuring IGMP Snooping

3.17.1 Overview

1. IGMP Snooping

IGMP snooping allows switches to listen for and analyze IGMP (Internet Group Management Protocol) messages in order to determine which switch ports are connected to hosts that are interested in specific multicast groups. By forwarding multicast traffic only to these ports, IGMP snooping helps to prevent unnecessary flooding of multicast traffic to all ports on the network, thereby improving network efficiency and security.

2. Unknown Multicast Packet

Unknown multicast packets are multicast packets transmitted on a network, whose destination addresses are multicast group addresses that are not learned or identified by the switch.

3.17.2 Configuration Steps

Choose **Network-Wide > Workspace > WLAN Optimization > Advanced Settings**.

Enable **IGMP Snooping**, select the action for unknown multicast packets, and click **Save**.

Network Optimization Scheduled Optimization Optimization Record 802.11k/v Roaming Optimization **Advanced**

IGMP Snooping Device Group:

When this feature is enabled, the AP converts multicast packets to unicast packets for a higher data rate and reduced airtime usage.
 To enhance user experience, you are advised to enable this feature in scenarios with high multicast traffic on air interfaces or slow network connections.
 Setting the unknown multicast action to "Discard" may lead to dropping of multicast packets sent by specific clients. In such cases, set the unknown multicast action to "Flood" for those specific clients.

IGMP Snooping

Unknown Multicast

Action

Caution

- You are advised to enable this function when a large number of multicast packets are transmitted and the network is congested to improve the user experience.
- If you set the action for unknown multicast packets to **Discard**, multicast packets sent by certain clients may be discarded. Therefore, exercise caution when performing this configuration.

3.18 Configuring Healthy Mode

Access the configuration page:

- Method 1: Choose **Network-Wide > Workspace > Wireless > Wi-Fi > Healthy Mode**.
- Method 2: Choose **One-Device**. Click the device model, and choose **Config > WLAN > Wi-Fi > Healthy Mode**.

Select **Device Group** from the drop-down list box. Click **Enable** to enable the healthy mode. You are allowed to set the effective time period for the healthy mode.

After the healthy mode is enabled, the transmit power and the Wi-Fi coverage area will decrease. The healthy mode may reduce signal strength and cause network stalling. You are advised to disable it or enable it when the network is idle.

Wi-Fi List **Healthy Mode**

Healthy Mode Device Group:

Enable ?

Effective Time ?

3.19 Configuring XPress

- (1) Go to the page for configuration.
 - Method 1: Choose **Network-Wide > Workspace > Wireless > Wi-Fi > Wi-Fi List**. Select the Wi-Fi network, and click **Edit**.
 - Method 2: Choose **One-Device**. Click the device model, and choose **Config > WLAN > Wi-Fi > Wi-Fi List**. Select the Wi-Fi network, and click **Edit**.
- (1) Click to expand advanced settings, turn on **XPress** in the expanded settings and click **OK**. After XPress is enabled, the gaming traffic will be prioritized, ensuring a more stable gaming experience.

Band Steering (The 5G-supported client will access 5G radio preferentially.)

XPress (The client will experience faster speed.)

Layer 3 Roaming ? (The client will keep the IP address unchanged on the Wi-Fi network.)

802.11r ? (After this feature is enabled, roaming time is reduced to achieve fast transition.)

3.20 Configuring Wireless Schedule

- (1) Go to the page for configuration.
 - Method 1: Choose **Network-Wide > Workspace > Wireless > Wi-Fi > Wi-Fi List**. Select the Wi-Fi network, and click **Edit**.
 - Method 2: Choose **One-Device**. Click the device model, and choose **Config > WLAN > Wi-Fi > Wi-Fi List**. Select the Wi-Fi network, and click **Edit**.
- (2) Click to expand advanced settings, select a scheduled time span to turn on Wi-Fi and click **OK**. Clients will be allowed to access the Internet only in the specified time span.

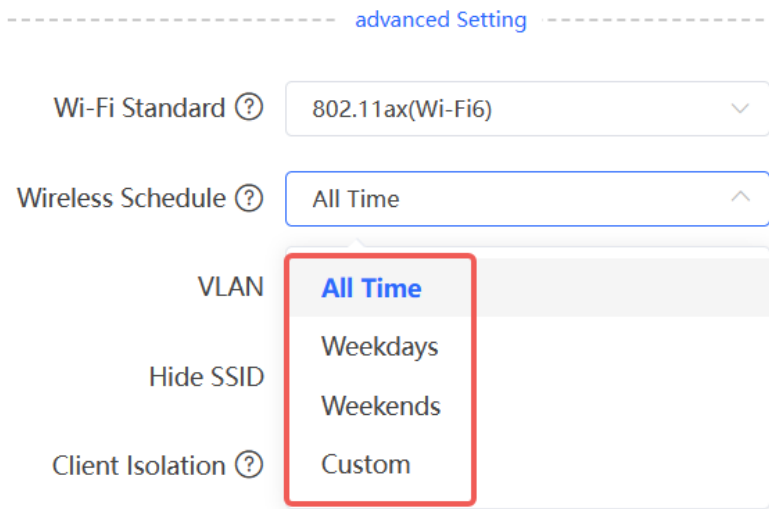

3.21 Enabling Reeye Mesh

Choose **Network-Wide > Workspace > Wireless > AP Mesh**.

After Reeye Mesh is enabled, you can set up a Mesh network through Mesh pairing between the devices that support Reeye Mesh. You can press the **Mesh** button on the device to automatically discover a new device for Mesh pairing or log in to the management page to select a new device for Mesh pairing. Reeye Mesh is enabled on the device by default.

After Reeye Mesh is enabled, the devices that support Reeye Mesh can be paired through wireless or wired connection to set up a Mesh network. Auto link optimization is supported in the Mesh network.

i Mesh link optimization algorithm: The algorithm not only covers signal strength, wireless mode, antenna streams and bandwidth parameters, but also considers the attenuation of Mesh hops. The Mesh system will select the optimal uplink automatically for the AP based on the link optimization algorithm.

Enable

Save

3.22 Domain Proxy

Go to the configuration page:

- Method 1: Choose **Network-Wide > Workspace > Wireless > Domain Proxy**.
- Method 2: Choose **One-Device**. Click the device model, and choose **Config > WLAN > Domain Proxy**.

i Note

The method 2 is supported only when the AP is the master device.

When a client accesses a Wi-Fi network, the message "No Internet connection" or "The Wi-Fi is not connected to the Internet" may be displayed. The possible cause is that the client's operating system introduces an Internet detection mechanism. Generally, the detection mechanism sends a probe packet to a specified domain name and evaluates whether the wireless network can access the Internet based on the detection result. If the DNS

server takes a long time to parse a domain name or returns a probe node with a long delay, the probe may be deemed unreachable, causing a false network unavailability.

After the **Domain Proxy** function is enabled, the device returns the preset domain name node to the client, reducing the misjudgment of network unavailability of the client.

Domain Proxy

Enable

User Configuration List

[+ Add](#) [Delete Selected](#)

<input type="checkbox"/>	Domain Name	IP	Action
No Data			

Up to 32 entries can be added.

Total 0 < 1 > 10/page

Click **+Add**, enter the preset domain name and IP address, and click **OK**.

Add ×

* Domain Name

* IP

3.23 Client Association

Choose **Network-Wide > Workspace > Wireless > Client Association**.

Click **Add Association**. Select the client and the associated device. You can associate the client with a specified AP on the network to reduce remote association and improve the wireless experience.

Client Association Enter MAC [+ Add Association](#)

<input type="checkbox"/>	Client	IP/MAC	Associated Device ?	Signal Strength ↕	Action
No Data					

Up to 128 entries can be added. Total 0 < 1 > 10/page

Add Association
×

* Client

* Associated Device ?

[Advanced Settings](#)

Click **Advanced Settings** to configure the SSID for client association and to enable **Forced Association**.

Add Association
×

* Client

* Associated Device ?

[Advanced Settings](#)

SSID

Forced Association

Enabling this feature will forcefully associate the client with a specific AP. However, since the client cannot initiate automatic association, this may cause disconnection and unsuccessful association attempts.

⚠ Caution
 The **Forced Association** feature may cause the client to go offline or fail to associate with the AP. Therefore, exercise caution when performing this configuration.

3.24 Configuring AP Load Balancing

3.24.1 Overview

The AP load balancing function is used to balance the load of APs in the wireless network. When APs are added to a load balancing group, clients will automatically associate with the APs with light load when the APs in the group are not load balanced. AP load balancing supports two modes:

- **Client Load Balancing:** The load is balanced according to the number of associated clients. When a large number of clients have been associated with an AP and the count difference to the AP with the lightest load has reached the specified value, the client can only associate with another AP in the group.

- **Traffic Load Balancing:** The load is balanced according to the traffic on the APs. When the traffic on an AP is large and the traffic difference to the AP with the lightest load has reached the specified value, the client can only associate with another AP in the group.

Example: Add AP1 and AP2 into a group and select client load balancing. Set both the client count threshold and difference to 3. AP1 is associated with 5 clients and AP2 is associated with 2 clients, triggering load balancing. New clients' attempt to associate to AP1 will be denied, and therefore they can associate only with AP2.

After a client request is denied by an AP and it fails to associate with another AP in the group, the client will keep trying to associate with this AP. If the client attempts reach the specified value, the AP will permit connection of this client, ensuring that the user can normally access the Internet.

3.24.2 Configuring Client Load Balancing

Choose **Network-Wide > Workspace > Wireless > Load Balancing**.

Click **Add**. In the dialog box that appears, set **Type** to **Client Load Balancing**, and configure **Group Name**, **Members**, and **Rule**.

Load Balancing

+ Add
Delete Selected

By grouping APs in the same area into a load balancing group, they can collaborate to control the access of wireless clients and to achieve optimal traffic distribution.

For example, when AP1 and AP2 are added to the same load balancing group, with the load balancing type set to Client Load Balancing and a strategy to trigger load balancing when one AP has 3 clients and the load-balancing threshold is 3, if AP1 has 5 clients and AP2 has 2 clients, any new client trying to connect to AP1 will be denied access and redirected to AP2, achieving load balancing between the two APs.

<input type="checkbox"/>	Group Name	Type	Rule	Members	Action
No Data					

Up to 32 entries can be added.

Add
×

* Group Name

* Type Client Load Balancing ▼

* Rule

Load balancing is triggered when the number of clients connected to an AP in a group reaches ?, and the client count difference between the AP and other APs in the group exceeds . Once a client has been denied access to an AP in the group for a total of 10 attempts, it will be allowed to connect to that AP again upon the next attempt.

* Members Enter an AP name or SN. ▼

Cancel
OK

Table 3-5 Client Load Balancing Configuration Parameters

Parameter	Description
Group Name	Enter the name of the AP load balancing group.
Type	Select Client Load Balancing .
Rule	<p>Configure a detailed load balancing rule, including the maximum number of clients allowed to associate with an AP, the difference between the currently associated client count and client count on the AP with the lightest load, and the number of attempts to the AP with full load.</p> <p>By default, when an AP is associated with 3 clients and the difference between the currently associated client count and client count on the AP with the lightest load reaches 3, clients can associate only to another AP in the group. After a client association is denied by an AP for 10 times, the client will be allowed to associate to the AP upon the next attempt.</p>
Members	Specify the APs to be added to the AP load balancing group.

3.24.3 Configuring Traffic Load Balancing

Choose **Network-Wide > Workspace > Wireless > Load Balancing**.

Click **Add**. In the dialog box that appears, set **Type** to **Traffic Load Balancing**, and configure **Group Name**, **Members**, and **Rule**.

Load Balancing + Add Delete Selected

By grouping APs in the same area into a load balancing group, they can collaborate to control the access of wireless clients and to achieve optimal traffic distribution.
 For example, when AP1 and AP2 are added to the same load balancing group, with the load balancing type set to Client Load Balancing and a strategy to trigger load balancing when one AP has 3 clients and the load-balancing threshold is 3, if AP1 has 5 clients and AP2 has 2 clients, any new client trying to connect to AP1 will be denied access and redirected to AP2, achieving load balancing between the two APs.

<input type="checkbox"/>	Group Name	Type	Rule	Members	Action
No Data					

Up to 32 entries can be added.

Add ×

* Group Name

* Type Traffic Load Balancing ▼

* Rule

Load balancing is triggered when the traffic on an AP in a group reaches *100Kbps, and the traffic difference between the AP and other APs in the group exceeds x 100Kbps. Once a client has been denied access to an AP in the group for a total of 10 attempts, it will be allowed to connect to that AP again upon the next attempt.

* Members Enter an AP name or SN. ▼

Cancel
OK

Table 3-6 Traffic Load Balancing Configuration Parameters

Parameter	Description
Group Name	Enter the name of the AP load balancing group.
Type	Select Traffic Load Balancing .
Rule	Configure a detailed load balancing rule, including the maximum traffic allowed on an AP, the difference between the current traffic and the traffic on the AP with the lightest load, and the number of attempts to the AP with full load. By default, when the traffic load on an AP reaches 500 Kbit/s and the difference between the current traffic and the traffic on the AP with the lightest load reaches 500 Kbit/s, clients can associate only to another AP in the group. After a client association is denied by an AP for 10 times, the client will be allowed to associate to the AP upon the next attempt.
Members	Specify the APs to be added to the AP load balancing group.

3.25 Wireless Authentication

3.25.1 Overview

Wireless authentication verifies the identity of users on a wireless network. Only authenticated users can access the network, ensuring wireless network security. You can configure authentication-free for wireless STAs (IP address/MAC address), public IP addresses, and domain names. Users can directly use network services or access specific websites without entering the username, password, or other information.

To use the wireless authentication function, ensure that the AP is added to Ruijie Cloud and is online. Then, configure a portal template on Ruijie Cloud and apply it to a specific SSID. When STAs connect to this SSID and access the network, the AP allows STAs added to the authentication-free lists configured on the web interface (excluding those added to the MAC address blacklist) to access the network without authentication. The AP forbids STAs whose MAC addresses are added to the MAC address blacklist configured on the web interface from accessing the network. For other users or domain names, the AP redirects them to the portal authentication page. Users need to complete identity verification on the portal page.

The following four authentication modes are supported:

- One-click Login: indicates login without the username and password.
- Voucher: indicates login with a random eight-digit password.
- Account: indicates login with the account and password.
- SMS: indicates login with the phone number and code.

Two or more authentication modes can be configured in a portal template. When multiple authentication modes are configured, users can select an authentication mode on the portal page.

3.25.2 Configuring One-click Login on Ruijie Cloud

1. Configuring a Portal Template with the Authentication Mode Set to One-click Login

- (1) Log in to Ruijie Cloud, choose **Project > Configuration > Auth & Accounts > Authentication > Captive Portal**, and select a network that needs to configure wireless authentication.
- (2) Click **Add Captive Portal** to open the portal template configuration page.

Captive Portal ?



New Authentication Function

- New version upgrade, support AP/Gateway unified configuration
- Support multiple login methods, one-click login, Voucher, Account, SMS verification, registered account
- Support multi-language and flexible customization of Portal pages.

Add Captive Portal

- (3) Click **Add Page** to customize a portal page.

Portal Page ?

- (4) Configure basic information of the portal template.

Portal Basic Settings

Portal Name:

Login Options: One-click Login

Access Duration (Min): Unlimited 15 30 60 Custom

Voucher

Account

SMS

Registration

Facebook Account ?

Show Balance Page:

Post-login URL:

Table 3-7 Basic Information of the Portal Template

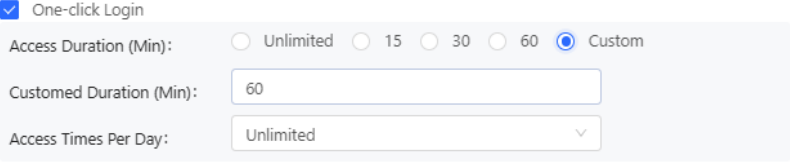
Parameter	Description
Portal Name	Indicates the name of a captive portal template.
Login Options	<p>Select One-click Login, which indicates login without the username and password. You can set Access Duration and Access Times Per Day.</p> 
Show Balance Page	Indicates the available duration, time, or data after portal authentication.
Post-login URL	Indicates the URL that is displayed after portal authentication.

(5) Configure visual settings of the portal template.

Portal Visual Settings

Logo:

Logo Image:

Logo Position:

Background : Picture Solid Color

Background Image: 

Background Mask Color: #999999

Welcome Message : Text Picture

English

Default Language:

Welcome Text:

Marketing Message:

Terms & Conditions:

Copyright:

One-click Login

Login Button:

Advertisement :

Welcome Text Color: #ffffff

Welcome Text Size:

Button Color: #0066ff

Button Text Color: #ffffff

Link Color: #ffffff

Text Color in Box: #ffffff

Mobile Desktop

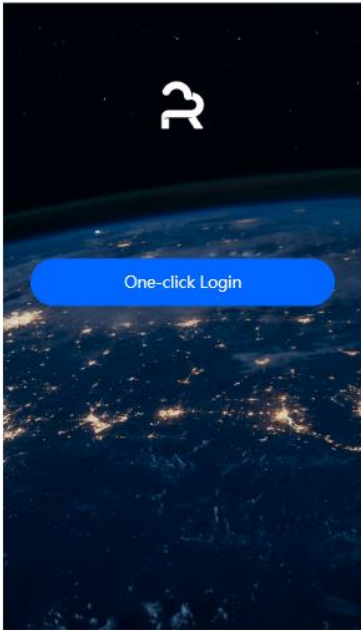



Table 3-8 Basic Information of the Portal Page

Parameter	Description
Logo	Select whether to display the logo image.
Logo Image	When Logo is set to Image , upload the logo picture or select the default logo.
Logo Position	Select the logo position (Upper, Middle, or Lower).
Background	Select the background with the image or the solid color.

Parameter	Description
Background Image	When Background is set to Image , upload the background image or select the default image.
Background Mask Color	When Background is set to Solid Color , configure the background color. The default value is #ffffff.
Welcome Message	Select the welcome message with the image or text.
Language	<p>Select the language of the portal page and configure the content displayed on the portal page as required. You can click  to add portal pages in other languages.</p> <ul style="list-style-type: none"> ● Welcome Message: Select the welcome message with the image or text. ● Marketing message: Enter the marketing message. ● Terms & Conditions: Enter terms and conditions. ● Copyright: Enter the copyright. ● One-click Login: After One-click Login is enabled, you can customize the button name displayed on the portal page, which is set to One-click Login by default. <p>One-click Login</p> <p>Login Button: <input type="text" value="One-click Login"/></p>
Advertisement	Select whether to display the advertisement.
Welcome Text Color	Select the welcome message text color. The default value is #ffffff.
Welcome Text Size	Select the welcome text size.
Button Color	Select the button color. The default value is #0066ff.
Button Text Color	Select the button text color. The default value is #ffffff.
Link Color	Select the link color. The default value is #ffffff.
Text Color in Box	Select the text color in the box. The default value is #ffffff.

(6) After the configuration, click **OK** to save the portal template configurations.

2. Configuring Policy Info

Configure basic information of the policy info to add captive portal. After the configuration, click **OK** for the configurations to take effect.

Note

When **Encryption Mode** is set to a value other than **WPA2-Enterprise(802.1x)**, the **Captive Portal** page is available. You can select whether to perform wireless authentication.

Policy Info

* Policy Name:

Policy Mode : Inner Local External

Authentication Device : Router AP

* SSID:

Seamless Online:

Seamless Online Period:

Portal Escape:

Table 3-9 Basic Information of the Captive Portal

Parameter	Description
Policy Name	Indicates the name of a captive portal template.
Policy Mode	Indicates the authentication mode to which the captive portal applies: Inner: Cloud-based authentication. The built-in authentication server in the public cloud is used for authentication. Local: Device-based local authentication and acceleration. Portal pages and accounts in the cloud are synchronized with the device for local authentication and acceleration. External: Third-party authentication, facilitating integration between the device and a third-party authentication server for authentication.
Authentication Device	Indicates the device that performs the authentication. When there is a router on the network, you are advised to enable authentication on the router. You can perform authentication on either an access point (AP) or a router. AP: An AP acts as the N/AS. Router: A router or gateway acts as the N/AS responsible for performing authentication at the gateway exit. Reeye AP Authentication: RAP, ReeyeOS 1.219 or later version. This parameter is not required if the policy mode is Local.

Parameter	Description
Network	<p>Indicates the wired network that requires authentication. Enter the network segment in this field.</p> <p>Users connecting to the wired network corresponding to this network segment must be authenticated.</p> <p>This parameter is required if the Authentication Device is Router.</p>
SSID	<p>Indicates the network name of the Wi-Fi network that requires authentication.</p> <p>Users connecting to this wireless network must be authenticated.</p> <p>This parameter is required if the Authentication Device is AP.</p>
Seamless Online	<p>After this function is enabled, if the first authentication is successful, subsequent connections to this Wi-Fi network will automatically be authenticated within a certain period of time.</p>
Seamless Online Period	<p>Indicates the time period for seamless online. If the first authentication is successful, subsequent connections to this Wi-Fi network will automatically be authenticated within this period of time.</p>
Portal Page	<p>Indicates the portal page that is displayed after portal authentication.</p> <p>Click Current Project to select the portal page for an existing project.</p> <p>Click Shared Portals to select an existing portal page.</p> <p>Click Add Page to customize a portal page.</p>

3.25.3 Configuring Voucher Authentication on Ruijie Cloud

1. Configuring a Portal Template with the Authentication Mode Set to Voucher

- (1) Log in to Ruijie Cloud, choose **Project > Configuration > Auth & Accounts > Authentication > Captive Portal**, and select a network that needs to configure wireless authentication.
- (2) Click **Add Captive Portal** to open the portal template configuration page.

[Captive Portal](#)

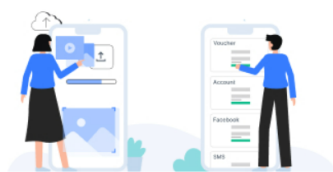

New Authentication Function

- New version upgrade, support AP/Gateway unified configuration
- Support multiple login methods, one-click login, Voucher, Account, SMS verification, registered account
- Support multi-language and flexible customization of Portal pages.

[Add Captive Portal](#)

- (3) Click **Add Page** to customize a portal page.

Portal Page ?

(4) Configure basic information of the portal template.

Portal Basic Settings

Portal Name:

Login Options:

- One-click Login
- Voucher
- Account
- SMS
- Registration
- Facebook Account ?

Show Balance Page:

Post-login URL:

Table 3-10 Basic Information of the Portal Template

Parameter	Description
Portal Name	Indicates the name of a captive portal template.
Login Options	Select Voucher , which indicates login with a random eight-digit password.
Show Balance Page	Indicates the available duration, time, or data after portal authentication.
Post-login URL	Indicates the URL that is displayed after portal authentication.

(5) Configure visual settings of the portal template.

Portal Page
✕

Portal Visual Settings

Logo:

Logo Image:

Logo Position:

Background : Picture Solid Color

Background Image:

Background Mask Color:

Welcome Message : Text Picture

English +

Default Language:

Welcome Text:

Marketing Message:

Terms & Conditions:

Copyright:

Voucher

Title:

Code Placeholder:

Login Button:

Switching Button:

Advertisement :

Welcome Text Color:

Welcome Text Size:

Button Color:

Button Text Color:

Link Color:

Text Color in Box:

Mobile
Desktop
Reset style

Table 3-11 Basic Information of the Portal Page

Parameter	Description
Logo	Select whether to display the logo image.

Parameter	Description
Logo Image	When Logo is set to Image , upload the logo picture or select the default logo.
Logo Position	Select the logo position (Upper, Middle, or Lower).
Background	Select the background with the image or the solid color.
Background Image	When Background is set to Image , upload the background image or select the default image.
Background Mask Color	When Background is set to Solid Color , configure the background color. The default value is #ffffff.
Welcome Message	Select the welcome message with the image or text.
Language	<p>Select the language of the portal page and configure the content displayed on the portal page as required. You can click  to add portal pages in other languages.</p> <ul style="list-style-type: none"> ● Welcome Message: Select the welcome message with the image or text. ● Marketing message: Enter the marketing message. ● Terms & Conditions: Enter terms and conditions. ● Copyright: Enter the copyright. ● Voucher Login: After Voucher Login is enabled, you can customize the names of controls related to voucher authentication. <p>Voucher</p> <p>Title: <input type="text" value="Voucher Login"/></p> <p>Code Placeholder: <input type="text" value="Access Code"/></p> <p>Login Button: <input type="text" value="Login"/></p> <p>Switching Button: <input type="text" value="Voucher Login"/></p>
Advertisement	Select whether to display the advertisement.
Welcome Text Color	Select the welcome message text color. The default value is #ffffff.
Welcome Text Size	Select the welcome text size.
Button Color	Select the button color. The default value is #0066ff.
Button Text Color	Select the button text color. The default value is #ffffff.
Link Color	Select the link color. The default value is #ffffff.
Text Color in Box	Select the text color in the box. The default value is #ffffff.

(6) After the configuration, click **OK** to save the portal template configurations.

2. Configuring Policy Info

Configure basic information of the policy info to add captive portal. After the configuration, click **OK** for the configurations to take effect.

Note

When **Encryption Mode** is set to a value other than **WPA2-Enterprise(802.1x)**, the **Captive Portal** page is available. You can select whether to perform wireless authentication.

Policy Info

* Policy Name:

Policy Mode : Inner Local External

Authentication Device : Router AP

* SSID:

Seamless Online:

Seamless Online Period:

Portal Escape:

Table 3-12 Basic Information of the Captive Portal

Parameter	Description
Policy Name	Indicates the name of a captive portal template.
Policy Mode	Indicates the authentication mode to which the captive portal applies: Inner: Cloud-based authentication. The built-in authentication server in the public cloud is used for authentication. Local: Device-based local authentication and acceleration. Portal pages and accounts in the cloud are synchronized with the device for local authentication and acceleration. External: Third-party authentication, facilitating integration between the device and a third-party authentication server for authentication.

Parameter	Description
Authentication Device	<p>Indicates the device that performs the authentication.</p> <p>When there is a router on the network, you are advised to enable authentication on the router. You can perform authentication on either an access point (AP) or a router.</p> <p>AP: An AP acts as the N/AS.</p> <p>Router: A router or gateway acts as the N/AS responsible for performing authentication at the gateway exit.</p> <p>Reyee AP Authentication: RAP, ReyeeOS 1.219 or later version.</p> <p>This parameter is not required if the policy mode is Local.</p>
Network	<p>Indicates the wired network that requires authentication. Enter the network segment in this field.</p> <p>Users connecting to the wired network corresponding to this network segment must be authenticated.</p> <p>This parameter is required if the Authentication Device is Router.</p>
SSID	<p>Indicates the network name of the Wi-Fi network that requires authentication.</p> <p>Users connecting to this wireless network must be authenticated.</p> <p>This parameter is required if the Authentication Device is AP.</p>
Seamless Online	<p>After this function is enabled, if the first authentication is successful, subsequent connections to this Wi-Fi network will automatically be authenticated within a certain period of time.</p>
Seamless Online Period	<p>Indicates the time period for seamless online. If the first authentication is successful, subsequent connections to this Wi-Fi network will automatically be authenticated within this period of time.</p>
Portal Page	<p>Indicates the portal page that is displayed after portal authentication.</p> <p>Click Current Project to select the portal page for an existing project.</p> <p>Click Shared Portals to select an existing portal page.</p> <p>Click Add Page to customize a portal page.</p>

3. Adding a Voucher

- (1) Log in to Ruijie Cloud, choose **Project > Auth & Accounts > Accounts > User Management**, and select a network in this account.
- (2) Configure a user group.
 - a On the **User Group** tab, click **Add**.

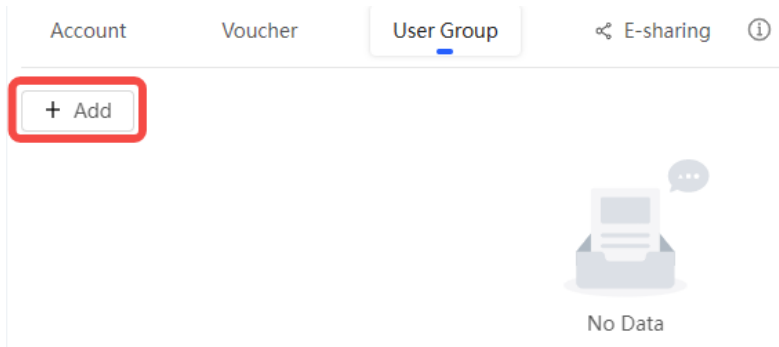

b Configure user group parameters. After the configuration, click **OK**.

Add user group
✕

* User group name

User Group Policy

Price

Concurrent devices

Period

Quota ⓘ

Maximum upload rate

Maximum download rate

Bind MAC on first use

User Group Name: indicates the user group name.

Price: indicates the price of the user group. Mark user groups by numeral. The current version has no impact on network usage.

Concurrent Devices: indicates the number of concurrent devices for one account.

Period: indicates the maximum validity time of an account. The maximum value is counted after the client passes authentication and successfully accesses the Internet.

Quota: indicates the maximum amount of data transfer.

Maximum upload rate: indicates the maximum upload rate.

Maximum download rate: indicates the maximum download rate.

Bind MAC on first use: indicates that the MAC address of the first device used will be bound and other devices used by the same user will be prohibited from accessing the Internet.

(3) Configure a voucher.

a On the **Voucher** tab, click **Add voucher**.

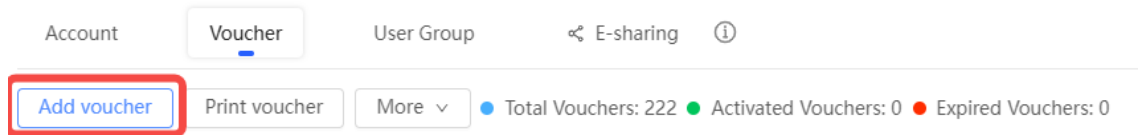

b Configure voucher parameters. After the configuration, click **OK**.

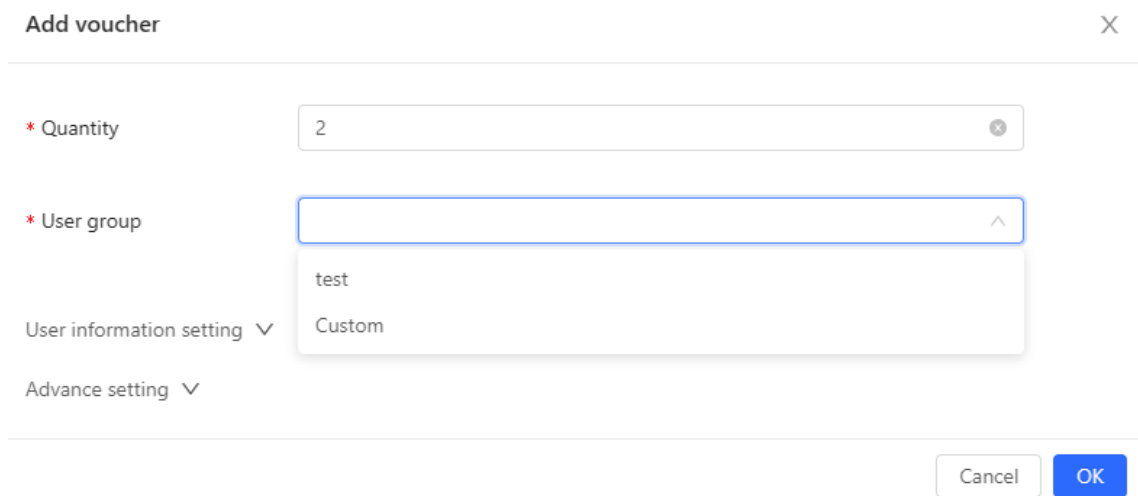

Quantity: Enter the quantity of the voucher to print. When the value is set to 1, you can add a voucher and configure the name and the email address. When the value is greater than 1, you can add vouchers in batches. In this case, you can only configure the name and email address separately after the vouchers are added.

User group: Select a created user group from the drop-down list. If the created user group does not meet the requirements, click **Custom** to create a user group.

User information setting: Configure user information, which is optional.

Advance setting:

o **Voucher code type:** Set the value to Alphanumeric 0-9, a-z, Alphanumeric a-z, or Numeric 0-9.

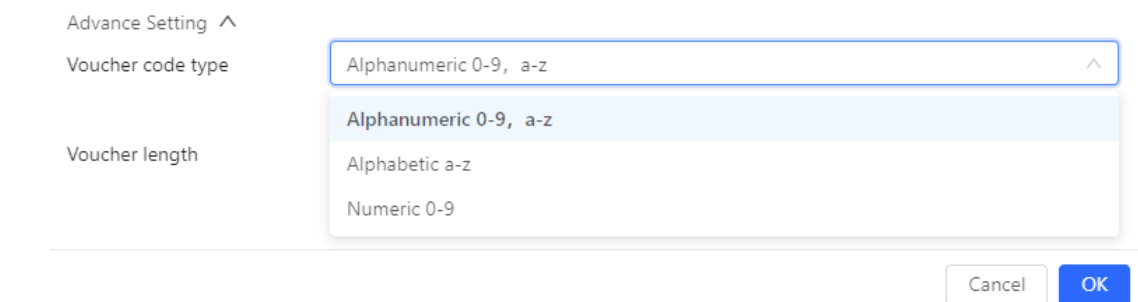

o **Voucher length:** Select the voucher length. The value ranges from 6 to 9.

Voucher length

6

6

7

8

9

(4) Obtain the voucher code from the voucher list.

Account **Voucher** User Group E-sharing ⓘ

Add voucher Print voucher More ▾ Total Vouchers: 4 Activated Vouchers: 0 Expired Vouchers: 0 Voucher 🔍 Filter 🗑️

<input type="checkbox"/>	Voucher code	User Group	Period	Created at	Activated at	Expired at	Operation
<input type="checkbox"/>	fqyhmg	1	Unlimited	2022-08-12 18:34:31	-	-	✎ 🔄 🗑️
<input type="checkbox"/>	dxwqkh	1	Unlimited	2022-08-12 18:34:31	-	-	✎ 🔄 🗑️
<input type="checkbox"/>	t5nq76	1	Unlimited	2022-08-12 11:09:07	-	-	✎ 🔄 🗑️
<input type="checkbox"/>	jsz75g	1	Unlimited	2022-08-12 11:09:07	-	-	✎ 🔄 🗑️

4 in total < 1 > 20 / page ▾

3.25.4 Configuring Account Authentication on Ruijie Cloud

1. Configuring a Portal Template with the Authentication Mode Set to Account

- (1) Log in to Ruijie Cloud, choose **Project > Configuration > Auth & Accounts > Authentication > Captive Portal**, and select a network that needs to configure wireless authentication.
- (2) Click **Add Captive Portal** to open the portal template configuration page.

▄ Captive Portal ⓘ



New Authentication Function

- New version upgrade, support AP/Gateway unified configuration
- Support multiple login methods, one-click login, Voucher, Account, SMS verification, registered account
- Support multi-language and flexible customization of Portal pages.

Add Captive Portal

- (3) Click **Add Page** to customize a portal page.

Portal Page 

(4) Configure basic information of the portal template.

Portal Basic Settings

Portal Name:

Login Options:

- One-click Login
- Voucher
- Account
- SMS
- Registration
- Facebook Account 

Show Balance Page:

Post-login URL:

Table 3-13 Basic Information of the Portal Template

Parameter	Description
Portal Name	Indicates the name of a captive portal template.
Login Options	Select Account , which indicates login with the account and password.
Show Balance Page	Indicates the available duration, time, or data after portal authentication.
Post-login URL	Indicates the URL that is displayed after portal authentication.

(5) Configure visual settings of the portal template.

Portal Page
✕

Portal Visual Settings

Logo:

Logo Image:

Logo Position:

Background : Picture Solid Color

Background Image:

Background Mask Color:

Welcome Message : Text Picture

English +

Default Language:

Welcome Text:

Marketing Message:

Terms & Conditions:

Copyright:

Account

Title:

Account Placeholder:

Password Placeholder:

Login Button:

Mobile
Desktop
Reset style

Table 3-14 Basic Information of the Portal Page

Parameter	Description
Logo	Select whether to display the logo image.

Parameter	Description
Logo Image	When Logo is set to Image , upload the logo picture or select the default logo.
Logo Position	Select the logo position (Upper, Middle, or Lower).
Background	Select the background with the image or the solid color.
Background Image	When Background is set to Image , upload the background image or select the default image.
Background Mask Color	When Background is set to Solid Color , configure the background color. The default value is #ffffff.
Welcome Message	Select the welcome message with the image or text.
Language	<p>Select the language of the portal page and configure the content displayed on the portal page as required. You can click  to add portal pages in other languages.</p> <ul style="list-style-type: none"> ● Welcome Message: Select the welcome message with the image or text. ● Marketing message: Enter the marketing message. ● Terms & Conditions: Enter terms and conditions. ● Copyright: Enter the copyright. ● Account Login: After Account Login is enabled, you can customize the names of the controls related to account authentication. <div style="border: 1px solid #ccc; padding: 10px; margin-top: 10px;"> <p>Account</p> <p>Title: <input type="text" value="Account Login"/></p> <p>Account Placeholder: <input type="text" value="Account"/></p> <p>Password Placeholder: <input type="text" value="Password"/></p> <p>Login Button: <input type="text" value="Login"/></p> <p>Switching Button: <input type="text" value="Account Login"/></p> </div>
Advertisement	Select whether to display the advertisement.
Welcome Text Color	Select the welcome message text color. The default value is #ffffff.
Welcome Text Size	Select the welcome text size.
Button Color	Select the button color. The default value is #0066ff.
Button Text Color	Select the button text color. The default value is #ffffff.
Link Color	Select the link color. The default value is #ffffff.
Text Color in Box	Select the text color in the box. The default value is #ffffff.

(6) After the configuration, click **OK** to save the portal template configurations.

2. Configuring Policy Info

Configure basic information of the policy info to add captive portal. After the configuration, click **OK** for the configurations to take effect.

Note

When **Encryption Mode** is set to a value other than **WPA2-Enterprise(802.1x)**, the **Captive Portal** page is available. You can select whether to perform wireless authentication.

Policy Info

* Policy Name:

Policy Mode : Inner Local External

Authentication Device : Router AP

* SSID:

Seamless Online:

Seamless Online Period:

Portal Escape:

Table 3-15 Basic Information of the Captive Portal

Parameter	Description
Policy Name	Indicates the name of a captive portal template.
Policy Mode	Indicates the authentication mode to which the captive portal applies: Inner: Cloud-based authentication. The built-in authentication server in the public cloud is used for authentication. Local: Device-based local authentication and acceleration. Portal pages and accounts in the cloud are synchronized with the device for local authentication and acceleration. External: Third-party authentication, facilitating integration between the device and a third-party authentication server for authentication.

Parameter	Description
Authentication Device	<p>Indicates the device that performs the authentication.</p> <p>When there is a router on the network, you are advised to enable authentication on the router. You can perform authentication on either an access point (AP) or a router.</p> <p>AP: An AP acts as the N/AS.</p> <p>Router: A router or gateway acts as the N/AS responsible for performing authentication at the gateway exit.</p> <p>Reyee AP Authentication: RAP, ReyeeOS 1.219 or later version.</p> <p>This parameter is not required if the policy mode is Local.</p>
Network	<p>Indicates the wired network that requires authentication. Enter the network segment in this field.</p> <p>Users connecting to the wired network corresponding to this network segment must be authenticated.</p> <p>This parameter is required if the Authentication Device is Router.</p>
SSID	<p>Indicates the network name of the Wi-Fi network that requires authentication.</p> <p>Users connecting to this wireless network must be authenticated.</p> <p>This parameter is required if the Authentication Device is AP.</p>
Seamless Online	<p>After this function is enabled, if the first authentication is successful, subsequent connections to this Wi-Fi network will automatically be authenticated within a certain period of time.</p>
Seamless Online Period	<p>Indicates the time period for seamless online. If the first authentication is successful, subsequent connections to this Wi-Fi network will automatically be authenticated within this period of time.</p>
Portal Page	<p>Indicates the portal page that is displayed after portal authentication.</p> <p>Click Current Project to select the portal page for an existing project.</p> <p>Click Shared Portals to select an existing portal page.</p> <p>Click Add Page to customize a portal page.</p>

3. Adding an Account

- (1) Log in to Ruijie Cloud, choose **Project > Auth & Accounts > Accounts > User Management**, and select a network in this account.
- (2) Configure a user group.
 - a On the **User Group** tab, click **Add**.

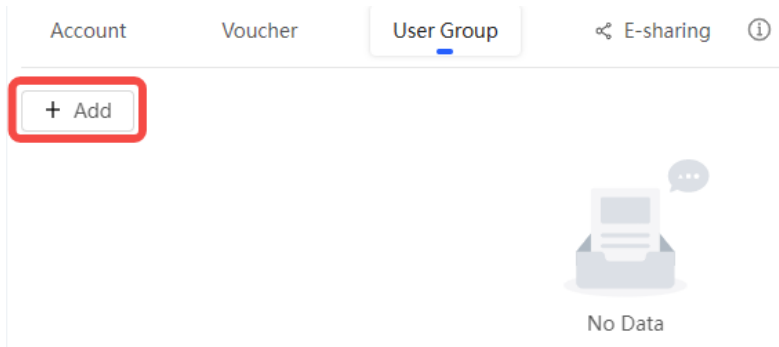

b Configure user group parameters. After the configuration, click **OK**.

Add user group
✕

* User group name

User Group Policy

Price

Concurrent devices

Period

Quota ⓘ

Maximum upload rate

Maximum download rate

Bind MAC on first use

User Group Name: indicates the user group name.

Price: indicates the price of the user group. Mark user groups by numeral. The current version has no impact on network usage.

Concurrent Devices: indicates the number of concurrent devices for one account.

Period: indicates the maximum validity time of an account. The maximum value is counted after the client passes authentication and successfully accesses the Internet.

Quota: indicates the maximum amount of data transfer.

Maximum upload rate: indicates the maximum upload rate.

Maximum download rate: indicates the maximum download rate.

Bind MAC on first use: indicates that the MAC address of the first device used will be bound and other devices used by the same user will be prohibited from accessing the Internet.

(3) On the **Account** tab, add an account. Accounts can be added manually or through batch import.

- Adding an account manually

Click **Add an Account**, set parameters about the account, and click **OK**.

Add account
✕

* User name

* Password

* User group

Allow VPN connection

Tips: By enabling this option, the user can use this account to log in remotely using a VPN.

User information setting ▼

Cancel
OK

User name: The value is a string of less than 32 characters, consisting of letters, numerals, and underscores.

Password: The value is a string of less than 32 characters, consisting of letters, numerals, and underscores.

User group: Select a created user group from the drop-down list. If the created user group does not meet the requirements, click **Custom** to create a user group.

Allow VPN connection: By enabling this option, the user can use this account to log in remotely using a VPN.

User information setting: You can expand it to have more user information displayed, including the first name, last name, email, phone number, and alias.

- Adding accounts through batch import

a Click **Bulk import**.

Bulk import accounts X

Step1: Download and fill in the device information in the template. Up to 500 records can be imported each time.

Account and Password fields are required. Please enter less than 32 characters, consisting of letters, numbers or underscores.



Please select an .xls or .xlsx file

Download Template

- b Click **Download Template** to download the template.
- c Edit the template and save it.

- ⚠ Caution**
- **Account, Password, and User Group** are mandatory.
 - Check that the user group already exists and the added accounts are not duplicate with existing accounts.

Account	Password	First name	Last name	Alias	User group	Email
test2	test2				test	
test3	test3				test	
test4	test4				test	

- d Click **Please select an .xls or .xlsx file** to upload the file. After uploading, users are automatically created.

Account Voucher User Group E-sharing ⓘ

Add account **Bulk import** One-click send More ▾ Total Accounts: 3 Activated Accounts: 0 Expired Accounts: 0

<input type="checkbox"/>	Account	Password	User group	Status ⓘ	Period	First name	Alias	Created at	Activated at	Ex	Operation
<input type="checkbox"/>	test3	test3	test	Not used	30Minutes	Empty	Empty	2023-02-13 16:42:21	-		🗑️ 🔄 📄
<input type="checkbox"/>	test4	test4	test	Not used	30Minutes	Empty	Empty	2023-02-13 16:42:21	-		🗑️ 🔄 📄
<input type="checkbox"/>	test2	test2	test	Not used	30Minutes	Empty	Empty	2023-02-13 16:42:21	-		🗑️ 🔄 📄

3 in total < 1 > 10 / page ▾

3.25.5 Configuring SMS Authentication on Ruijie Cloud

1. Adding a Twilio Account

Prerequisites

A Twilio account has been applied for from the Twilio official website (<https://www.twilio.com/login>).

i Note

A Twilio account is used to send the SMS verification code.

Configuration Steps

(1) Log in to Ruijie Cloud and choose  > **Account**.

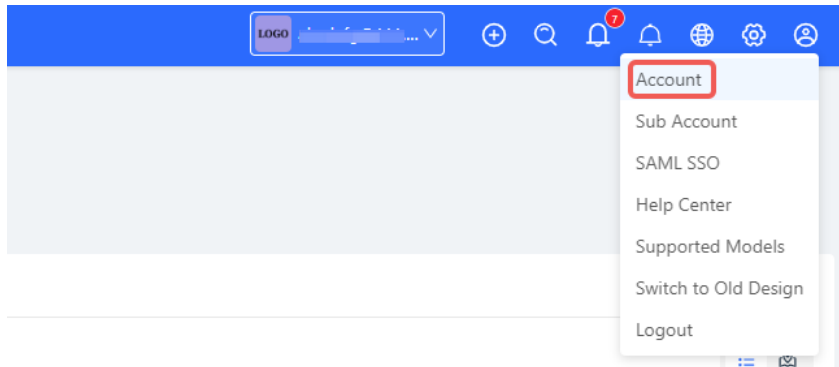

(2) Add Twilio account information and click **Save**.

[Modify Twilio Account](#) [How to apply twilio account?](#)

Twilio Account SID:

Auth Token:

Auth Phone:

2. Configuring a Portal Template with the Authentication Mode Set to SMS

- (1) Log in to Ruijie Cloud, choose **Project > Configuration > Auth & Accounts > Authentication > Captive Portal**, and select a network that needs to configure wireless authentication.
- (2) Click **Add Captive Portal** to open the portal template configuration page.

Captive Portal 



New Authentication Function

- New version upgrade, support AP/Gateway unified configuration
- Support multiple login methods, one-click login, Voucher, Account, SMS verification, registered account
- Support multi-language and flexible customization of Portal pages.

(3) Click **Add Page** to customize a portal page.

Portal Page [?]

(4) Configure basic information of the portal template.

Portal Basic Settings

Portal Name:

Login Options:

- One-click Login
- Voucher
- Account
- SMS

Twilio Account SID:

Auth Token:

Auth Phone:

- Registration
- Facebook Account [?]

The SMS configuration cannot be empty

Show Balance Page:

Post-login URL:

Table 3-16 Basic Information of the Portal Template

Parameter	Description
Portal Name	Indicates the name of a captive portal template.
Login Options	Select SMS , which indicates login with the phone number and code.
Show Balance Page	Indicates the available duration, time, or data after portal authentication.
Post-login URL	Indicates the URL that is displayed after portal authentication.

(5) Configure visual settings of the portal template.

Portal Page ✕

Portal Visual Settings

Logo:

Logo Image:

Logo Position:

Background : Picture Solid Color

Background Image:

Background Mask Color:

Welcome Message : Text Picture

English +

Default Language:

Welcome Text:

Marketing Message:

Terms & Conditions:

Copyright:

SMS

Title:

Phone Placeholder:

Code Placeholder:

Code Button:

Advertisement :

Welcome Text Color:

Welcome Text Size:

Button Color:

Button Text Color:

Link Color:

Text Color in Box:

Mobile Desktop Reset style

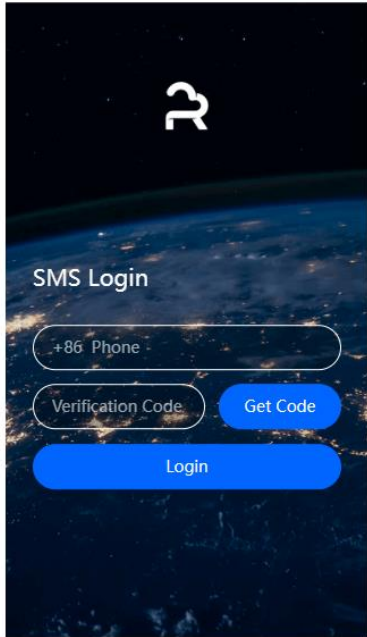

The mobile view shows a dark background with a satellite image of Earth. At the top is a white logo. Below it, the text "SMS Login" is displayed. There is a text input field for a phone number with a placeholder "+86 Phone". Below that is another text input field for a "Verification Code" and a blue button labeled "Get Code". At the bottom is a large blue button labeled "Login".

Table 3-17 Basic Information of the Portal Page

Parameter	Description
Logo	Select whether to display the logo image.
Logo Image	When Logo is set to Image , upload the logo picture or select the default logo.
Logo Position	Select the logo position (Upper, Middle, or Lower).
Background	Select the background with the image or the solid color.
Background Image	When Background is set to Image , upload the background image or select the default image.
Background Mask Color	When Background is set to Solid Color , configure the background color. The default value is #ffffff.
Welcome Message	Select the welcome message with the image or text.
Language	<p>Select the language of the portal page and configure the content displayed on the portal page as required. You can click  to add portal pages in other languages.</p> <ul style="list-style-type: none"> ● Welcome Message: Select the welcome message with the image or text. ● Marketing message: Enter the marketing message. ● Terms & Conditions: Enter terms and conditions. ● Copyright: Enter the copyright. ● SMS Login: After SMS Login is enabled, you can customize the names of the controls related to SMS authentication. <p>SMS</p> <p>Title: <input type="text" value="SMS Login"/></p> <p>Phone Placeholder: <input type="text" value="Phone"/></p> <p>Code Placeholder: <input type="text" value="Verification Code"/></p> <p>Code Button: <input type="text" value="Get Code"/></p> <p>Login Button: <input type="text" value="Login"/></p> <p>Switching Button: <input type="text" value="SMS Login"/></p>
Advertisement	Select whether to display the advertisement.
Welcome Text Color	Select the welcome message text color. The default value is #ffffff.
Welcome Text Size	Select the welcome text size.
Button Color	Select the button color. The default value is #0066ff.

Parameter	Description
Button Text Color	Select the button text color. The default value is #ffffff.
Link Color	Select the link color. The default value is #ffffff.
Text Color in Box	Select the text color in the box. The default value is #ffffff.

(6) After the configuration, click **OK** to save the portal template configurations.

3. Configuring Policy Info

Configure basic information of the policy info to add captive portal. After the configuration, click **OK** for the configurations to take effect.

Note

When **Encryption Mode** is set to a value other than **WPA2-Enterprise(802.1x)**, **Go to the "Captive Portal" page** is available and you can select whether to perform wireless authentication.

Policy Info

* Policy Name:

Policy Mode : Inner Local External

Authentication Device : Router AP

* SSID:

Seamless Online:

Seamless Online Period:

Portal Escape:

Table 3-18 Basic Information of the Captive Portal

Parameter	Description
Policy Name	Indicates the name of a captive portal template.

Parameter	Description
Policy Mode	<p>Indicates the authentication mode to which the captive portal applies:</p> <p>Inner: Cloud-based authentication. The built-in authentication server in the public cloud is used for authentication.</p> <p>Local: Device-based local authentication and acceleration. Portal pages and accounts in the cloud are synchronized with the device for local authentication and acceleration.</p> <p>External: Third-party authentication, facilitating integration between the device and a third-party authentication server for authentication.</p>
Authentication Device	<p>Indicates the device that performs the authentication.</p> <p>When there is a router on the network, you are advised to enable authentication on the router. You can perform authentication on either an access point (AP) or a router.</p> <p>AP: An AP acts as the N/AS.</p> <p>Router: A router or gateway acts as the N/AS responsible for performing authentication at the gateway exit.</p> <p>Reyee AP Authentication: RAP, ReyeeOS 1.219 or later version.</p> <p>This parameter is not required if the policy mode is Local.</p>
Network	<p>Indicates the wired network that requires authentication. Enter the network segment in this field.</p> <p>Users connecting to the wired network corresponding to this network segment must be authenticated.</p> <p>This parameter is required if the Authentication Device is Router.</p>
SSID	<p>Indicates the network name of the Wi-Fi network that requires authentication.</p> <p>Users connecting to this wireless network must be authenticated.</p> <p>This parameter is required if the Authentication Device is AP.</p>
Seamless Online	<p>After this function is enabled, if the first authentication is successful, subsequent connections to this Wi-Fi network will automatically be authenticated within a certain period of time.</p>
Seamless Online Period	<p>Indicates the time period for seamless online. If the first authentication is successful, subsequent connections to this Wi-Fi network will automatically be authenticated within this period of time.</p>
Portal Page	<p>Indicates the portal page that is displayed after portal authentication.</p> <p>Click Current Project to select the portal page for an existing project.</p> <p>Click Shared Portals to select an existing portal page.</p> <p>Click Add Page to customize a portal page.</p>

3.25.6 Configuring Registration on Ruijie Cloud

1. Configuring a Portal Template with the Authentication Mode Set to One-click Login

- (1) Log in to Ruijie Cloud, choose **Project > Configuration > Auth & Accounts > Authentication > Captive Portal**, and select a network that needs to configure wireless authentication.
- (2) Click **Add Captive Portal** to open the portal template configuration page.

Captive Portal ?



New Authentication Function

- New version upgrade, support AP/Gateway unified configuration
- Support multiple login methods, one-click login, Voucher, Account, SMS verification, registered account
- Support multi-language and flexible customization of Portal pages.

Add Captive Portal

- (3) Click **Add Page** to customize a portal page.

Portal Page ?

- (4) Configure basic information of the portal template.

Portal Basic Settings

Portal Name:

Login Options: One-click Login

Access Duration (Min): Unlimited 15 30 60 Custom

Voucher

Account

SMS

Registration

Facebook Account ?

Show Balance Page:

Post-login URL:

Table 3-19 Basic Information of the Portal Template

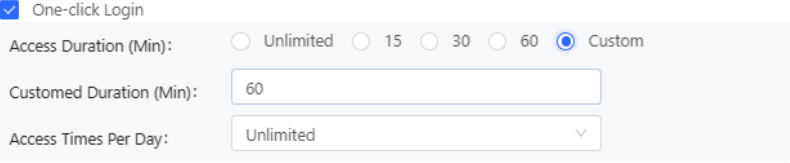
Parameter	Description
Portal Name	Indicates the name of a captive portal template.
Login Options	<p>Select One-click Login, which indicates login without the username and password. You can set Access Duration and Access Times Per Day.</p> 
Show Balance Page	Indicates the available duration, time, or data after portal authentication.
Post-login URL	Indicates the URL that is displayed after portal authentication.

(5) Configure visual settings of the portal template.

Portal Visual Settings

Logo:

Logo Image:

Logo Position:

Background : Picture Solid Color

Background Image: 

Background Mask Color: #999999

Welcome Message : Text Picture

English

Default Language:

Welcome Text:

Marketing Message:

Terms & Conditions:

Copyright:

One-click Login

Login Button:

Advertisement :

Welcome Text Color: #ffffff

Welcome Text Size:

Button Color: #0066ff

Button Text Color: #ffffff

Link Color: #ffffff

Text Color in Box: #ffffff

Mobile
Desktop
Reset style

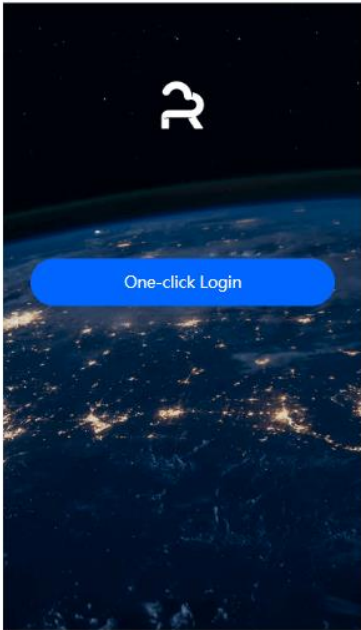



Table 3-20 Basic Information of the Portal Page

Parameter	Description
Logo	Select whether to display the logo image.
Logo Image	When Logo is set to Image , upload the logo picture or select the default logo.
Logo Position	Select the logo position (Upper, Middle, or Lower).
Background	Select the background with the image or the solid color.

Parameter	Description
Background Image	When Background is set to Image , upload the background image or select the default image.
Background Mask Color	When Background is set to Solid Color , configure the background color. The default value is #ffffff.
Welcome Message	Select the welcome message with the image or text.
Language	<p>Select the language of the portal page and configure the content displayed on the portal page as required. You can click  to add portal pages in other languages.</p> <ul style="list-style-type: none"> ● Welcome Message: Select the welcome message with the image or text. ● Marketing message: Enter the marketing message. ● Terms & Conditions: Enter terms and conditions. ● Copyright: Enter the copyright. ● One-click Login: After One-click Login is enabled, you can customize the button name displayed on the portal page, which is set to One-click Login by default. <p>One-click Login</p> <p>Login Button: <input type="text" value="One-click Login"/></p>
Advertisement	Select whether to display the advertisement.
Welcome Text Color	Select the welcome message text color. The default value is #ffffff.
Welcome Text Size	Select the welcome text size.
Button Color	Select the button color. The default value is #0066ff.
Button Text Color	Select the button text color. The default value is #ffffff.
Link Color	Select the link color. The default value is #ffffff.
Text Color in Box	Select the text color in the box. The default value is #ffffff.

(6) After the configuration, click **OK** to save the portal template configurations.

2. Configuring Policy Info

Configure basic information of the policy info to add captive portal. After the configuration, click **OK** for the configurations to take effect.

Note

When **Encryption Mode** is set to a value other than **WPA2-Enterprise(802.1x)**, the **Captive Portal** page is available. You can select whether to perform wireless authentication.

Policy Info

* Policy Name:

Policy Mode : Inner Local External

Authentication Device : Router AP

* SSID:

Seamless Online:

Seamless Online Period:

Portal Escape:

Table 3-21 Basic Information of the Captive Portal

Parameter	Description
Policy Name	Indicates the name of a captive portal template.
Policy Mode	Indicates the authentication mode to which the captive portal applies: Inner: Cloud-based authentication. The built-in authentication server in the public cloud is used for authentication. Local: Device-based local authentication and acceleration. Portal pages and accounts in the cloud are synchronized with the device for local authentication and acceleration. External: Third-party authentication, facilitating integration between the device and a third-party authentication server for authentication.
Authentication Device	Indicates the device that performs the authentication. When there is a router on the network, you are advised to enable authentication on the router. You can perform authentication on either an access point (AP) or a router. AP: An AP acts as the N/AS. Router: A router or gateway acts as the N/AS responsible for performing authentication at the gateway exit. Reye AP Authentication: RAP, ReyeOS 1.219 or later version. This parameter is not required if the policy mode is Local.

Parameter	Description
Network	<p>Indicates the wired network that requires authentication. Enter the network segment in this field.</p> <p>Users connecting to the wired network corresponding to this network segment must be authenticated.</p> <p>This parameter is required if the Authentication Device is Router.</p>
SSID	<p>Indicates the network name of the Wi-Fi network that requires authentication.</p> <p>Users connecting to this wireless network must be authenticated.</p> <p>This parameter is required if the Authentication Device is AP.</p>
Seamless Online	<p>After this function is enabled, if the first authentication is successful, subsequent connections to this Wi-Fi network will automatically be authenticated within a certain period of time.</p>
Seamless Online Period	<p>Indicates the time period for seamless online. If the first authentication is successful, subsequent connections to this Wi-Fi network will automatically be authenticated within this period of time.</p>
Portal Page	<p>Indicates the portal page that is displayed after portal authentication.</p> <p>Click Current Project to select the portal page for an existing project.</p> <p>Click Shared Portals to select an existing portal page.</p> <p>Click Add Page to customize a portal page.</p>

3.25.7 Configuring an Authentication-Free User List on Web Interface

You can configure authentication-free for wireless STAs (IP address/MAC address), public IP addresses, and domain names. Users can directly use network services or access specific websites without entering the username, password, or other information.

1. Configuring an Authentication-Free User

- (1) Choose **Network-Wide > Workspace > Wireless > Wireless Auth > Allowlist > User Allowlist**.
- (2) Click **Add** to open the configuration page.

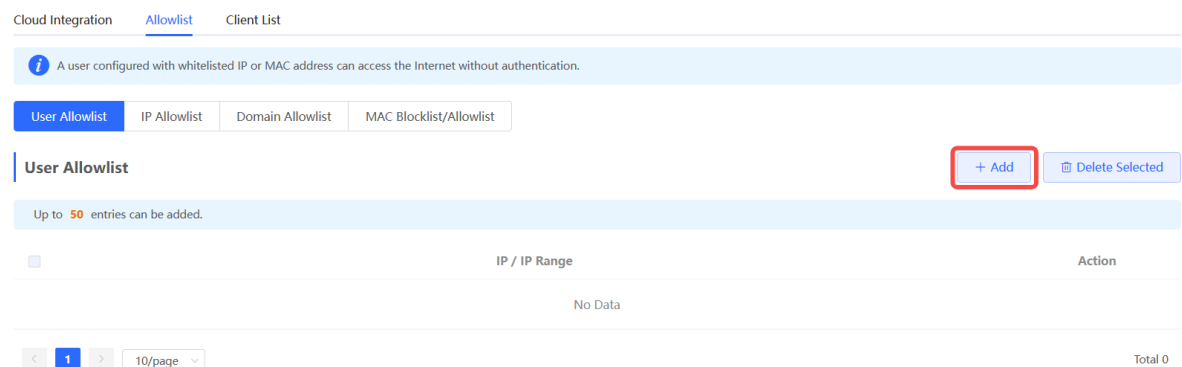

- (3) Configure an STA IP address or IP address range. After the configuration, click **OK** to save the configurations.

Add
×

* IP / IP Range

2. Configuring an Authentication-Free Public IP Address

- (1) Choose **Network-Wide > Workspace > Wireless > Wireless Auth > Allowlist > IP Allowlist**.
- (2) Click **Add** to open the configuration page.

Cloud Integration [Allowlist](#) [Client List](#)

i A user configured with whitelisted IP or MAC address can access the Internet without authentication.

User Allowlist
IP Allowlist
Domain Allowlist
MAC Blocklist/Allowlist

IP Allowlist

+ Add

Delete Selected

Up to **50** entries can be added.

	IP / IP Range	Action
No Data		

< 1 >
10/page
Total 0

- (3) Configure a public IP address or public IP address range. After the configuration, click **OK** to save the configurations.

Add
×

* IP / IP Range

3. Configuring a Domain Name Allowlist

- (1) Choose **Network-Wide > Workspace > Wireless > Wireless Auth > Allowlist > Domain Allowlist**.
- (2) Click **Add** to open the configuration page.

Cloud Integration [Allowlist](#) Client List

i A user configured with whitelisted IP or MAC address can access the Internet without authentication.

User Allowlist IP Allowlist **Domain Allowlist** MAC Blocklist/Allowlist

Domain Allowlist + Add Delete Selected

Up to 100 entries can be added.

<input type="checkbox"/>	URL	Action
No Data		

< 1 > 10/page Total 0

(3) Configure authentication-free websites. After the configuration, click **OK**.

Add ×

* URL

Cancel OK

4. Configuring a MAC Address Allowlist and Blocklist

STAs whose MAC addresses are added to the MAC address allowlist can access the network without authentication, and STAs whose MAC addresses are added to the MAC address blocklist are forbidden to access the network.

- (1) Choose **Network-Wide > Workspace > Wireless > Wireless Auth > Allowlist > MAC Blocklist/Allowlist**.
- (2) Click **Add** to open the MAC address allowlist or blocklist configuration page.

Cloud Integration [Allowlist](#) Client List

i A user configured with whitelisted IP or MAC address can access the Internet without authentication.

User Allowlist IP Allowlist Domain Allowlist **MAC Blocklist/Allowlist**

MAC Allowlist + Add Delete Selected

Up to 250 entries can be added.

<input type="checkbox"/>	MAC Address	Action
No Data		

< 1 > 10/page Total 0

MAC Blocklist + Add Delete Selected

Up to 250 entries can be added.

<input type="checkbox"/>	MAC Address	Action
No Data		

< 1 > 10/page Total 0

(3) Configure the MAC address of a wireless STA. After the configuration, click **OK**.

✕

Add

* MAC Address

3.25.8 Displaying Authenticated Users on web interface

Choose **Network-Wide > Workspace > Wireless > Wireless Auth > Client List** to display authenticated users.

Note

The client going offline will not disappear immediately. Instead, the client will stay on the list for three more minutes.

Cloud Integration Allowlist Client List

Client List

i The client going offline will not disappear immediately. Instead, the client will stay in the list for three more minutes.

	Username	IP	MAC Address	Online Time	Auth Type	Connect the SSID	Access Name	Action
No Data								

Total 0

3.25.9 Displaying Authenticated Users on Ruijie Cloud

Log in to Ruijie Cloud, choose **Project > Network > Clients > Auth Clients**, and select a network that needs to display authenticated users.

All 1 Wireless 0 Wired 1 Blocklist 0 Experience Trend Auth Clients Smart Clients

Portal Auth Clients

802.1X Auth Clients

Web History

Auth Failure Record

Auth Blocklist

Clear Auth Info

Blocklist

Status: Accounts:

Auth Method:

Accounts	IP	MAC	Auth Method	Online Time	Total Online Time	Authorized by
<div style="display: flex; justify-content: center; align-items: center;"> No Data </div>						

3.26 Configuring 802.1X Authentication

3.26.1 Overview

IEEE 802.1X is a port-based network access control standard that provides secure access services for LANs.

On an IEEE 802 LAN, a user can directly access network resources without authentication and authorization as long as it can connect to a network device. This uncontrolled behavior can bring security risks to the network. The IEEE 802.1X protocol was proposed to address the security issues on an IEEE 802 LAN.

The IEEE 802.1X protocol supports three security applications: Authentication, Authorization, and Accounting, abbreviated as AAA.

- **Authentication:** Determines whether a user can obtain access, and restricts unauthorized users.
- **Authorization:** Authorizes services available for authorized users, and controls the permissions of unauthorized users.
- **Accounting:** Records the usage of network resources by users, and provides a basis for traffic billing.

The 802.1X feature can be deployed on networks to control user authentication, authorization, and more.

An 802.1X network uses a typical client/server architecture, consisting of three entities: client, access device, and authentication server. A typical architecture is shown here.

Figure 3-1 Typical Architecture of 802.1X Network

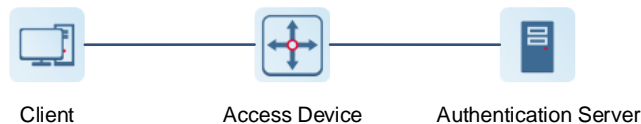

- The client is usually an endpoint device which can initiate 802.1X authentication through the client software. The client must support the Extensible Authentication Protocol over LANs (EAPoL) on the local area network.
- The access device is usually a network device (AP or switching device) that supports the IEEE 802.1X protocol. It provides an interface for clients to access the local area network, which can be a physical or a logical interface.
- The authentication server can realize user authentication, authorization, and accounting. Usually a RADIUS server is used as the authentication server.



Note

The RG-RAP APs only support the authentication.

3.26.2 Configuring 802.1X Authentication

- (1) Choose **Network-Wide > Workspace > Wireless > 802.1x Authentication**.
- (2) Click **Global 802.1x**. A pop-up window is displayed. Click **OK**.

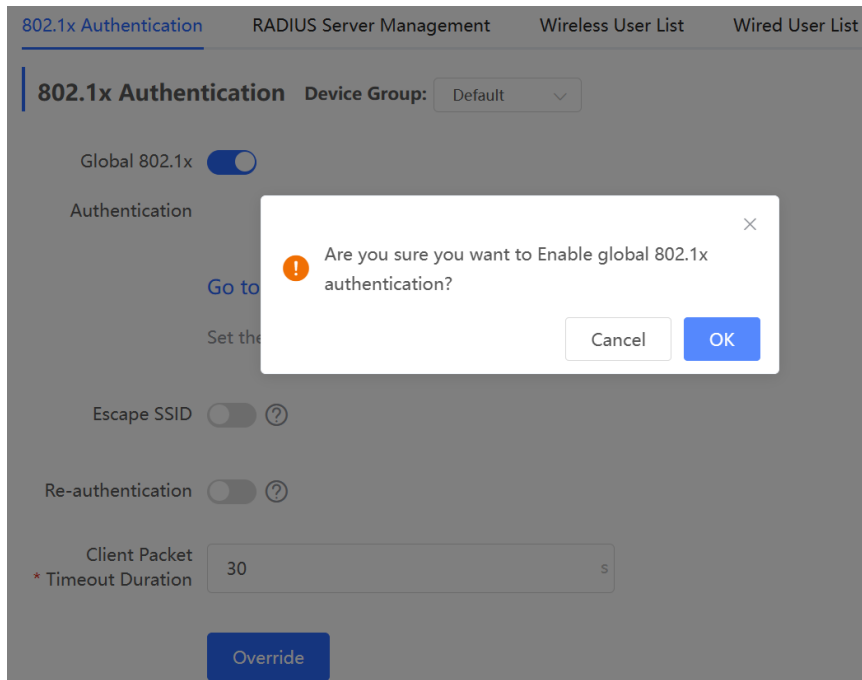

Enable the **Escape SSID** and configure parameters such as Escape SSID. Users can temporarily connect to the Escape SSID without a password when the authentication server is unavailable.

Escape SSID ?

* Escape SSID

* Security

* Wi-Fi Password

Toggle on **Re-authentication** and set the re-authentication interval. The re-authentication function performs periodic user authentication, and users who do not pass the periodic authentication will be disconnected.

⚠ Caution

The re-authentication interval must be set to 10800 seconds or above.

Re-authentication ?

* Re-auth Interval s

Client Packet Timeout Duration: The time limit for a client to wait for a response from the server. An authentication failure occurs after this time limit expires. The value range is 1 to 65535 seconds.

802.1x Authentication Device Group:

Global 802.1x

Authentication

[Go to Wi-Fi](#)

Set the security mode of the SSID to 802.1X (Enterprise).

Escape SSID ?

Re-authentication ?

Client Packet
* Timeout Duration s

(3) Add a server.

Before proceeding, make sure that the following conditions are met:

- The RADIUS server is ready and the following configurations have been completed.
 - A username and a password have been added for client login.
 - The firewall has been disabled. Otherwise, authentication messages may be blocked, leading to authentication failure.
 - The IP address of the device to be authenticated has been added as a trusted IP address on the RADIUS server.

- The network between the device and the RADIUS server is reachable.
- The IP addresses of the RADIUS server and the device to be authenticated have been obtained.

Click **Add Server group** to configure server group parameters. You can click **Edit** to edit the server group, and click **Delete** to delete the server group.

Note

- You need to add at least one server for each server group, and a maximum of five servers can be added.
 - Up to 20 server groups can be added under **RADIUS Server Management**.
-

802.1x Authentication [RADIUS Server Management](#) Wireless User List Wired User List

[Add Server group](#)

Up to 20 entries can be added.

Server group name	Server IP	Auth Port	Accounting Port	Shared Password	Action
group1	1.1.1.2	1812	1813	rujije	Edit Delete
	1.1.1.1	1812	1813	rujije	
group2	1.1.1.3	1812	1813	rujije	Edit Delete

You can click [+](#) **Add Server** to add multiple servers to a server group, and click [-](#) **Server** to delete a selected server.

Add ×

* Server group name

[-](#) **Server 1** [+](#)

* Server IP

* Server name

* Auth Port

* Accounting Port ?

* Shared Password

* Match Order ?

[+](#) **Add Server** [-](#)

Table 3-22 Server Group Parameters

Parameter	Description
Server group name	Name of RADIUS server group
Server IP	IP address of the RADIUS server.
Server name	Name of RADIUS server
Auth Port	The port number for the RADIUS server to perform user authentication.
Accounting Port	The port number for the RADIUS server to perform user accounting.

Parameter	Description
Shared Password	Shared key of the RADIUS server.
Match Order	The system supports up to five RADIUS servers. A larger value indicates a higher priority.

(4) Configure the server and click **Save**.

RADIUS Server Management
Add Server

Up to 5 entries can be added.

Server IP	Auth Port	Accounting Port	Shared Password	Match Order	Action
No Data					

Server global configuration

- * Packet Retransmission Interval s
- * Packet Retransmission Count time
- Server Detection
- * Detection Interval min
- * Detection Count time ?
- * Detection Username
- MAC Address Format ?

Save

Table 3-23 Server Global Configuration Parameters

Parameter	Description
Packet Retransmission Interval	Configure the interval during which the device sends a request to a RADIUS server before confirming that the RADIUS server is unreachable.
Packet Retransmission Count	Configure the number of times that the device sends requests to a RADIUS server before confirming that the RADIUS server is unreachable.
Server Detection	If this function is enabled, it is necessary to set the server detection cycle, server detection times, and server detection username. Determines the server status and whether to enable functions such as the escape function.
MAC Address Format	Configure the format of the MAC address used in attribute 31 (Calling-Station-ID) of a RADIUS message. The following formats are supported: <ul style="list-style-type: none"> ● Dotted hexadecimal format. For example, 00d0.f8aa.bbcc. ● IETF format. For example: 00-D0-F8-AA-BB-CC. ● Unformatted (default). For example: 00d0f8aabbcc

3.26.3 Viewing Wireless User List

When the 802.1X feature is configured globally, and a client is authenticated and connected to the network in a wireless manner, you can view the client in the **Wireless User List**.

Choose **Network-Wide > Workspace > Wireless > 802.1x Authentication > Wireless User List**.

802.1x Authentication RADIUS Server Management Wireless User List Wired User List

Description
The client going offline will not disappear immediately. Instead, the client will stay in the list for a more minutes.

Wireless User List

<input type="checkbox"/>	Name	IP	MAC Address	Online Time	Online Duration	Connect SSID	Access Name	Action
No Data								

Total 0

Click **Refresh** to view the latest user list.

If you want to disconnect a user from the network, select the user and click **Logout** under the **Action** column. You can also select multiple users and click **Batch Logout** to disconnect selected users.

3.26.4 Viewing Wired User List

When the 802.1X feature is configured globally, and a client is authenticated and connected to the network in a wired manner, you can view the client in the **Wired User List**.

Choose **Network-Wide > Workspace > Wireless > 802.1x Authentication > Wired User List**.

802.1x Authentication RADIUS Server Management Wireless User List Wired User List

Wired User List

<input type="checkbox"/>	Username	Status	Interface	MAC Address	Online Time	Online Duration	Access Name	Action
No Data								

Total 0

Click **Refresh** to view the latest user list.

If you want to disconnect a user from the network, select the user and click **Logout** under the **Action** column. You can also select multiple users and click **Batch Logout** to disconnect selected users.

4 Network Settings

Note

This chapter takes the currently logged in device as an example to describe the entry of each function setting page. If you need to configure other devices in the network, please refer to the following path to enter the configuration page of the corresponding device, and then configure the function: RG-RAP62-OD: Click [2.3 Managing Network Devices](#).

4.1 Switching Work Mode

4.1.1 Work Mode

See [1.4 Work Mode](#) for details.

4.1.2 Self-Organizing Network Discovery

When setting the work mode, you can set whether to enable the self-organizing network discovery function. This function is enabled by default.

After the self-organizing network discovery function is enabled, the device can be discovered in the network and discover other devices in the network. Devices network with each other based on the device status and synchronize global configuration. You can log in to the Web management page of any device in the network to check information about all devices in the network. After this function is enabled, clients can maintain and manage the current network more efficiently. You are advised to keep this function enabled.

If the self-organizing network discovery function is disabled, the device will not be discovered in the network and it runs in local device mode. After logging in to the Web page, you can configure and manage only the currently logged in device. If only one device is configured or global configuration does not need to be synchronized to the device, you can disable the self-organizing network discovery function.

4.1.3 Configuration Steps

Note

If you need to switch the work mode to wireless bridging mode, please see [4.5.2 Wireless Repeater](#) for details.

Access the configuration page:

- Method 1: Choose **One-Device**. Click the device model.
- Method 2: Choose **Network-Wide > Devices > AP**. Select the target device in the list and click **Manage**.

Click the current work mode to change the work mode.

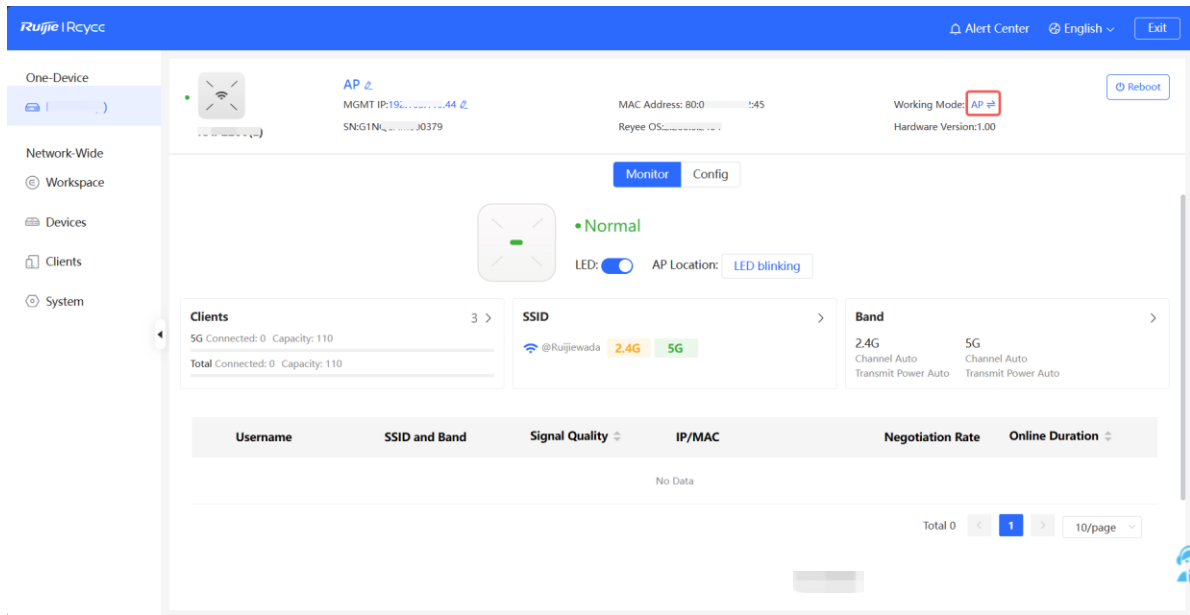

AC function switch: If a device works in the router mode and the self-organizing network discovery function is enabled, you can enable or disable the AC function. After the AC function is enabled, the device in the router mode supports the virtual AC function and can manage downlink devices. If this function is disabled, the device needs to be elected as an AC in self-organizing network mode and then manage downlink devices.

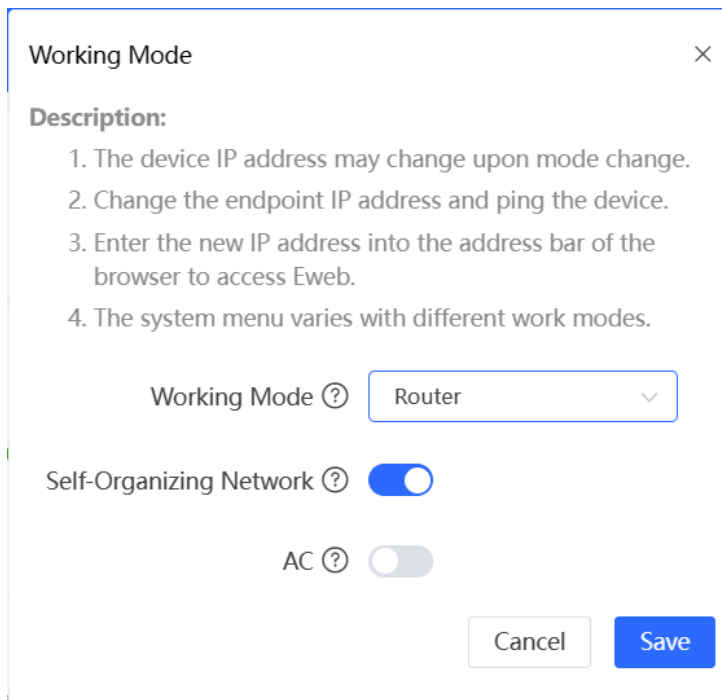

⚠ Caution

After the self-organizing network discovery is enabled, you can check the role of the device in self-organizing network mode.

4.2 Configuring Internet Connection Type (IPv4)

Access the configuration page:

- Method 1: Choose **One-Device**. Click the device model, and choose **Config > Network > WLAN > WAN**.
- Method 2: Choose **Network-Wide > Workspace > Wired > WAN > WAN**.

Select the Internet connection type after confirming with the ISP. For detailed configuration, see [1.5 Configuration Wizard \(Router Mode\)](#). After completing the configuration, click **Save**.

WAN WAN_v6 Settings

* Internet (?) ▼

Username and password are not required.

IP Address 192.168.110.65

Subnet Mask 255.255.255.0

Gateway 192.168.110.1

DNS Server 192.168.110.1

Dedicated DNS

Server (?)

----- Advanced Settings -----

VLAN ID

* MTU (?)

* MAC Address (?)

The device supports the following Internet connection types:

- **PPPoE**: This Internet connection type is supported only when the device works in routing mode. You need to manually configure the PPPoE username and password.
- **DHCP**: The current device will act as a DHCP client and apply for the IPv4 address/prefix from the upstream network device.
- **Static IP**: If this Internet connection type is selected, you need to manually configure a static IPv4 address, subnet mask, gateway address, and DNS server.

4.3 Configuring Internet Connection Type (IPv6)

Caution

This function is supported only when the device works in the AP mode.

Access the configuration page:

- Method 1: Choose **One-Device**. Click the device model, and choose **Config > Network > WLAN > WAN_V6 Settings**.
- Method 2: Choose **Network-Wide > Workspace > Wired > WAN > WAN_V6 Settings**.

Select the Internet connection type after confirming with the ISP. After completing the configuration, click **Save**.

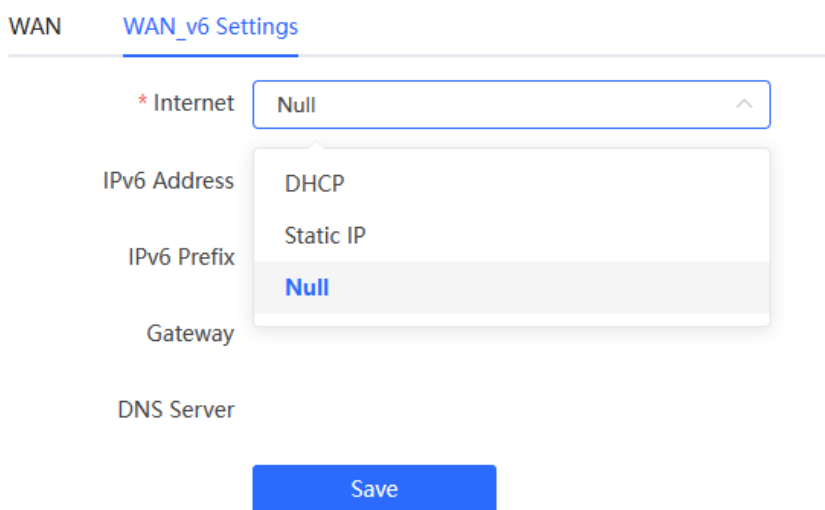

WAN [WAN_v6 Settings](#)

* Internet

IPv6 Address

IPv6 Prefix

Gateway

DNS Server

[Save](#)

The device supports the following Internet connection types:

- **DHCP**: The current device will act as a DHCPv6 client and apply for the IPv6 address/prefix from the upstream network device.
- **Static IP**: If this Internet connection type is selected, you need to manually configure a static IPv6 address, gateway address, and DNS server.
- **Null**: The IPv6 function is disabled on the current WAN port.

4.4 Configuring LAN Port

Caution

This function is not supported when the device works in AP mode.

Access the configuration page:

- Method 1: Choose **One-Device**. Click the device model, and choose **Config > Network > LAN > LAN Settings**.
- Method 2: Choose **Network-Wide > Workspace > Wired > LAN > LAN Settings**.

Click **Edit**. In the displayed dialog box, enter the IP address and subnet mask, and click **OK**. Change the IP address of the LAN port. Enter the new IP address in the browser and log in to the device again to configure and manage the device.

LAN Settings + Add Delete Selected

<input type="checkbox"/>	IP Address [?]	Subnet Mask [?]	VLAN ID [?]	Remarks	DHCP Server [?]	Start IP Address [?]	IP Count [?]	Lease Time (Min) [?]	Action
<input checked="" type="checkbox"/>	192.168.110.1	255.255.255.0	Default VLAN	-	Enabled	192.168.110.1	254	30	Edit Delete
<input type="checkbox"/>	192.168.2.1	255.255.255.0	2	-	Enabled	192.168.2.1	254	30	Edit Delete

Up to 8 entries can be added.

Edit ×

* IP Address

* Subnet Mask

Remarks

MAC Address

DHCP Server

Table 4-1 LAN Settings

Parameter	Description
IP Address	Default gateway for devices connected to the Internet through this LAN.
Subnet Mask	Subnet mask of devices on the LAN.
VLAN ID	VLAN ID.
Remarks	VLAN description.
DHCP Server	After this function is enabled, devices on the LAN can automatically obtain the IP address. You need to configure the start IP address, IP count and lease time, as well as DHCP server options. For details, see 4.10 Configuring DHCP Server
Start IP Address	Start IP address that a DHCP server automatically assigns to clients. The start IP address must be within the network segment calculated based on the IP address and subnet mask.
IP Count	The number of assignable IP addresses depends on the LAN segment and the start IP address.

Parameter	Description
Lease Time (Min)	Lease time of the automatically assigned IP addresses. When the lease time expires, devices on the LAN will obtain IP addresses again.

4.5 Configuring Repeater Mode

4.5.1 Wired Repeater

Choose **One-Device**. Click the device mode, and then choose **Config > Network > Work Mode**.

Connect a network cable from the WAN port (uplink LAN port) of the device to the upper-layer device.

Select **Access Point**, click **Check**, confirm the Wi-Fi settings of the AP, and then click **Save** to expand the network coverage.

 **Caution**

After the configuration is saved, connected clients will be disconnected from the network for a short period of time. You can reconnect the clients to the Wi-Fi network for restoration.

The device is working in **Access Point** mode.

Router
 Access Point
 Wireless Repeater

This mode allows you to establish a wired connection between a primary router and a secondary router, extending network coverage.
 **Cable Connection:** Please connect the WAN port of the local router to the LAN port of the primary router.
Tip: The local router is a secondary router. The local router Wi-Fi is managed by the primary router.

Access Point

Status **Enabled**

IP Address 192.168.110.45

Subnet Mask 255.255.255.0

DNS Server 192.168.110.1

Edit

4.5.2 Wireless Repeater

The wireless repeater mode extends the Wi-Fi coverage range of the primary device. The device supports the dual-link wireless repeater mode and can extend both 2.4 GHz and 5 GHz signals of the primary device.

 **Note**

- To avoid loops in wireless repeater mode, remove the network cable from the WAN port.
- Obtain the Wi-Fi name and Wi-Fi password of the upper-layer router.

Choose One-Device. Click the device mode, and then choose **Config > Network > Work Mode**.

Click **Wireless Repeater** and then click **Select**. A list of surrounding Wi-Fi signals pops up. A list of nearby 5 GHz Wi-Fi networks is displayed by default. You can switch from 5 GHz to 2.4 GHz band by selecting **2.4G** from the drop-down list box. You are advised to select a strong 5 GHz Wi-Fi network signal.

The device is working in **Access Point** mode.

Router
 Access Point
 Wireless Repeater

- This mode allows you to establish a wireless connection between the primary device and the local device that works as the secondary device, extending network coverage.
 - You are advised to select a 5G Wi-Fi of the primary device for better Internet experience.
- To avoid loops, wireless repeater is not allowed to be configured.

Wireless Repeater

Primary Device

* SSID



5G Wi-Fi List Select a target Wi-Fi.

SSID	BSSID	Security	Channel	RSSI	MLO
@Ruijie-sD2CE_plus_5G	4a:81:d4:9b:6c:e5	OPEN	36	-17 dBm High	Not supported
@Ruijie-sD2CE_plus_5G	c6:70:ab:18:71:39	OPEN	36	-27 dBm High	Not supported
rj-network	f2:82:3d:b9:3b:01	WPA2PSK	36	-78 dBm Low	Not supported
ruijie-guest	f2:82:3d:b9:3b:02	OPEN	36	-78 dBm Low	Not supported
ruijie-office	f2:82:3d:b9:3b:03	WPA2PSK	36	-78 dBm Low	Not supported

- Select the Wi-Fi signal of the upper-layer device that you want to extend. The configuration items of the local device are displayed. If the signal of the upper-layer device is encrypted, enter the Wi-Fi password of the upper-layer device.
- Configure Local Router Wi-Fi. You can select New Wi-Fi or Same as Primary Router Wi-Fi.
 - If you select **Same as Primary Router Wi-Fi**, the Wi-Fi settings of the router are automatically synchronized with those on the primary router. Generally, clients merge Wi-Fi signals with the same name into one Wi-Fi signal, and they can search out only the Wi-Fi signal of the primary router.

The device is working in **Access Point** mode.

Router
 Access Point
 Wireless Repeater

- This mode allows you to establish a wireless connection between the primary device and the local device that works as the secondary device, extending network coverage.
- You are advised to select a 5G Wi-Fi of the primary device for better Internet experience.

 To avoid loops, wireless repeater is not allowed to be configured.

Wireless Repeater

Primary Device

* SSID **ry-network**

* Wi-Fi Password

Local Device

Local Router Wi-Fi New Wi-Fi Same as Primary Router Wi-Fi

- If **New Wi-Fi** is selected, you can set a local Wi-Fi name and password. Clients will search out different Wi-Fi signals.

The device is working in **Access Point** mode.

Router
 Access Point
 Wireless Repeater

- This mode allows you to establish a wireless connection between the primary device and the local device that works as the secondary device, extending network coverage.
- You are advised to select a 5G Wi-Fi of the primary device for better Internet experience.

 To avoid loops, wireless repeater is not allowed to be configured.

Wireless Repeater

Primary Device

* SSID **ry-network**

* Wi-Fi Password

Local Device

Local Router Wi-Fi **New Wi-Fi** Same as Primary Router Wi-Fi

* SSID(2.4G)

* SSID(5G)

Wi-Fi Password

⚠ Caution

- After the configuration is saved, the AP will be disconnected from the Wi-Fi network and needs to connect to the new Wi-Fi network. Exercise caution when performing this operation. Record the new Wi-Fi name and password.
- You are advised to install the AP in a position where the RSSI is greater than two bars of signal to prevent signal loss. If the signal at the installation position is too weak, the Wi-Fi extension may fail or the quality of extended signal may be poor.

4.6 Creating a VLAN

⚠ Caution

This function is not supported when the device works in AP mode.

Access the configuration page:

- Method 1: Choose **One-Device**. Click the device model, and choose **Config > Network > LAN > LAN Settings**.
- Method 2: Choose **Network-Wide > Workspace > Wired > LAN > LAN Settings**.

A LAN can be classified into multiple VLANs. Click **Add** to create a VLAN.

LAN Settings DHCP Clients Static IP Addresses

LAN Settings + Add Delete Selected

<input type="checkbox"/>	IP Address ?	Subnet Mask ?	VLAN ID ?	Remarks	DHCP Server ?	Start IP Address ?	IP Count ?	Lease Time (Min) ?	Action
<input type="checkbox"/>	192.168.120.1	255.255.255.0	Default VLAN	-	Enabled	192.168.120.1	254	30	Edit Delete

Up to 8 entries can be added.

Add ×

* IP Address

* Subnet Mask

* VLAN ID

Remarks

MAC Address

DHCP Server

Table 4-2 VLAN Configuration

Parameter	Description
IP Address	IP address of the VLAN interface. The default gateway of devices that access the Internet through the current LAN should be set to this IP address.
Subnet Mask	Subnet mask of the IP address of the VLAN interface.
VLAN ID	VLAN ID.
Remark	VLAN description.
MAC	MAC address of the VLAN interface.

Parameter	Description
DHCP Server	Enable the DHCP server function. After it is enabled, devices on the LAN can automatically obtain IP addresses. After the DHCP service is enabled, you need to configure the start IP address to be assigned, number of IP addresses to be assigned, and address lease term for the DHCP server, and other DHCP server options. For details, see 4.10 Configuring DHCP Server .

⚠ Caution

VLAN configuration is associated with the configuration of the uplink device. Therefore, refer to the configuration of the uplink device when configuring a VLAN.

4.7 Configuring Port VLAN

⚠ Caution

The port VLAN can be configured only when the device works in AP mode.

Access the configuration page:

- Method 1: Choose **One-Device**. Click the device model, and choose **Config > Network > LAN > LAN Settings**.
- Method 2: Choose **Network-Wide > Workspace > Wired > LAN > LAN Settings**.

(1) On the **LAN Settings** tab page, turn on **Port VLAN**, and click **OK** in the confirmation dialog box.

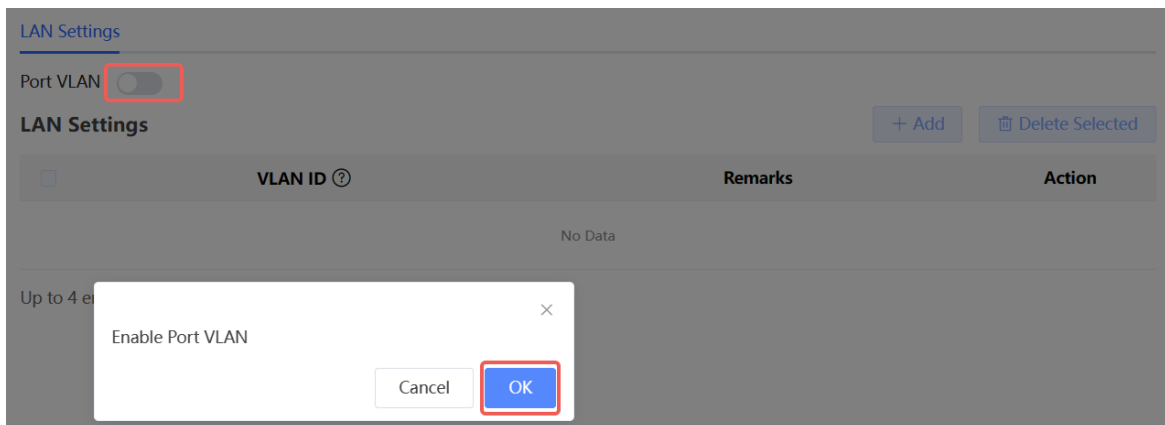

(2) Click **Add**. Enter the VLAN ID and description, and click **OK** to create a VLAN. The added VLAN is used to set the VLAN, to which a port belongs.

Add
×

* VLAN ID

Remarks

- (3) Switch to the **Port VLAN** tab page and configure VLANs for the port. Click the option box below the port, select the mapping between a VLAN and the port from the drop-down list box, and click **Save**.
- **Untagged:** Configure the VLAN as the native VLAN of the port. That is, when receiving a packet from this VLAN, the port removes the VLAN tag from the packet and forwards the packet. When receiving an untagged packet, the port adds the VLAN tag to the packet and forwards the packet through the VLAN. Only one VLAN can be configured as an untagged VLAN on each port.
 - **Tagged:** Configure the VLAN as an allowed VLAN of the port, but the VLAN cannot be the native VLAN. That is, VLAN packets carry the original VLAN tag when they are forwarded by the port.
 - **Non-added:** Configure the port not to allow packets from this VLAN to pass through. For example, if VLAN 10 and VLAN 20 are not added to port 2, port 2 will neither receive nor send packets from or to VLAN 10 and VLAN 20.

LAN Settings [Port VLAN](#)

i Please choose [LAN Settings](#) to create a VLAN first and configure port settings based on the VLAN.

Connected

Disconnected

LAN1

VLAN 1(WAN)	<div style="background-color: #ffc107; padding: 2px 5px; border: 1px solid #ffc107; display: inline-block;">Untagged</div> ▼
VLAN 10	<div style="background-color: #fff; padding: 2px 5px; border: 1px solid #ccc; display: inline-block;">Non-added</div> ▼

4.8 Changing MAC Address

Access the configuration page:

- Method 1: Choose **One-Device**. Click the device model, and choose **Config > Network > WAN > WAN**.

- Method 2: Choose **Network-Wide > Workspace > Wired > WAN > WAN**.

ISPs may restrict the access of devices with unknown MAC addresses to the Internet for the sake of security. In this case, you can change the MAC address of the WAN port.

Click to expand **Advanced Settings**, enter the MAC address, and click **Save**. You do not need to change the default MAC address unless in special cases.

In the router mode, change the MAC address of the LAN port on **LAN > LAN Settings**.

⚠ Caution

Changing the MAC address will disconnect the device from the network. You need to reconnect the device to the network or restart the device. Therefore, exercise caution when performing this operation.

----- Advanced Settings -----

VLAN ID

* MTU (?)

* MAC Address (?)

4.9 Changing MTU

Access the configuration page:

- Method 1: Choose **One-Device**. Click the device model, and choose **Config > Network > WAN > WAN**.
- Method 2: Choose **Network-Wide > Workspace > Wired > WAN > WAN**.

WAN interface MTU indicates the maximum transmission unit (MTU) allowed by the WAN interface. The default value is 1500 bytes, indicating the maximum data forwarding efficiency. Sometimes, ISP networks restrict the speed of large data packets or forbid large data packets from passing through. As a result, the network speed is unsatisfactory or even the network is disconnected. In this case, you can set the MTU value to a smaller value.

----- Advanced Settings -----

VLAN ID

* MTU (?)

* MAC Address (?)

4.10 Configuring DHCP Server

Caution

This function is not supported when the device works in AP mode.

4.10.1 DHCP Server

In the router mode, the DHCP server function can be enabled on the device to automatically assign IP addresses to clients so that clients connected to the LAN ports or Wi-Fi network of the device obtain IP addresses for Internet access.

4.10.2 Configuring the DHCP Server Function

Access the configuration page:

- Method 1: Choose **One-Device**. Click the device model, and choose **Config > Network > LAN > LAN Settings**.
- Method 2: Choose **Network-Wide > Workspace > Wired > LAN > LAN Settings**.

DHCP Server: The DHCP server function is enabled by default in the router mode. You are advised to enable the function if the device is used as the sole router in the network. When multiple routers are connected to the upper-layer device through LAN ports, disable this function.

Caution

If the DHCP server function is disabled on all devices in the network, clients cannot automatically obtain IP addresses. You need to enable the DHCP server function on one device or manually configure a static IP address for each client for Internet access.

Start: Enter the start IP address of the DHCP address pool. A client obtains an IP address from the address pool. If all the addresses in the address pool are used up, no IP address can be obtained from the address pool.

IP Count: Enter the number IP addresses in the address pool.

Lease Time(Min): Enter the address lease term. When a client is connected, the leased IP address is automatically renewed. If a leased IP address is not renewed due to client disconnection or network instability, the IP address will be reclaimed after the lease term expires. After the client connection is restored, the client can request an IP address again. The default lease term is 30 minutes.

Add
×

* IP Address

* Subnet Mask

* VLAN ID

Remarks

MAC Address

DHCP Server

* Start IP Address

* IP Count

* Lease Time (Min)

4.10.3 Displaying Online DHCP Clients

Access the configuration page:

- Method 1: Choose **One-Device**. Click the device model, and choose **Config > Network > LAN > DHCP Clients**.
- Method 2: Choose **Network-Wide > Workspace > Wired > LAN > DHCP Clients**.

Check information about an online client. Click **Convert to Static IP**. Then, the static IP address will be obtained each time the client connects to the network.

LAN Settings [DHCP Clients](#) Static IP Addresses

DHCP Clients

No.	Device Name	IP Address	MAC Address	Remaining Lease Time(min)	Status
<input type="checkbox"/>	nova-f5a-97	192.168.120.172	42:11:26:...	23	Convert to Static IP

Up to 300 static binding entries are supported.

Total 0 < 1 > 10/page

4.10.4 Displaying the DHCP Static IP Address List

Access the configuration page:

- Method 1: Choose **One-Device**. Click the device model, and choose **Config > Network > LAN > Static IP Addresses**.
- Method 2: Choose **Network-Wide > Workspace > Wired > LAN > Static IP Addresses**.

Click **Add**. In the displayed static IP address binding dialog box, enter the MAC address and IP address of the client to be bound, and click **OK**. After a static IP address is bound, the bound IP address will be obtained each time the client connects to the network.

LAN Settings DHCP Clients Static IP Addresses

Static IP Address List [Batch Import](#) [Batch Export](#) [+ Add](#) [Delete Selected](#)

No.	Device Name	IP Address	MAC Address	Action
No Data				

Up to 300 entries can be added. Total 0

Add ×

Device Name ?

* IP Address

* MAC Address

4.11 Configuring DNS

Choose **One-Device**. Click the device model, and choose **Config > Advanced > Local DNS**.

Enter the IP address of the DNS server and click **Save**. The local DNS server is optional. The device obtains the DNS server address from the connected uplink device by default. The default configuration is recommended. The available DNS service varies from region to region. You can consult the local ISP.

i The local DNS server is not required to be configured. By default, the device will get the DNS server address from the uplink device.

Local DNS server

4.12 Configuring Self-Healing Mesh

Choose **One-Device**. Click the device model, and choose **Config > Advanced > Self-Healing Mesh**.

After Reye Mesh is enabled, Self-Healing Mesh is automatically switched to Wireless Repeater mode to ensure normal service operation if a fault occurs on the wired link.

 After Reye Mesh is enabled, Self-Healing Mesh is automatically switched to Wireless Repeater mode to ensure normal service operation if a fault occurs on the wired link.

Enable

Save

4.13 Hardware Acceleration

Choose **One-Device**. Click the device model, and choose **Config > Advanced > Hardware Acceleration**.

After Hardware acceleration is enabled, the Internet access speed will be improved.

 After Hardware Acceleration is enabled, the Internet access speed will be improved and clients will not be rate-limited.

Enable

Save

4.14 Configuring Port Flow Control

Choose **One-Device**. Click the device model, and choose **Config > Advanced > Port Settings**.

When the LAN ports work at different rates, data congestion may occur, which can slow down the network speed and affect the Internet access experience. Enabling port flow control can help mitigate this problem.

 Port flow control can relieve the data congestion caused by ports at different speeds and improve the network speed.

Enable

Save

4.15 Configuring ARP Binding

Caution

This function is not supported when the device works in AP mode.

The device learns the IP and MAC addresses of network devices connected to ports of the device and generates ARP entries. You can bind ARP mappings to improve network security.

Choose **One-Device**. Click the device model, and choose **Config > Security > ARP List**.

ARP mappings can be bound in two ways:

- (1) Select a dynamic ARP entry in the ARP list and click **Bind**. You can select multiple entries to be bound at one time and click **Bind Selected** to bind them. To remove the binding between a static IP address and a MAC address, click **Delete** in the **Action** column.

ARP List 🔄 Search by IP Address/MAC Addr Q + Add 🔗 Bind Selected 🗑 Delete Selected

No.	Device Name	MAC Address	IP Address	Type	Action
<input type="checkbox"/> 1	Click to edit	30:0d:9e:d0:de:01	192.168.110.1	Dynamic	🔗 Bind

Up to 256 entries can be added. Total 1 < 1 > 10/page

- (2) Click **Add**, enter the IP address and MAC address to be bound, and click **OK**. The input box can display existing address mappings in the ARP list. You can click a mapping to automatically enter the address mapping.

Add ✕

Device Name ?

* IP Address

* MAC Address

4.16 IPv6 Settings

Caution

This function is supported only when the device works in the router mode.

4.16.1 Overview

Internet Protocol Version 6 (IPv6) is the next generation IP protocol designed by the Internet Engineering Task Force (IETF) to replace IPv4 and solve the IPv4 problems such as address depletion.

4.16.2 IPv6 Basic

1. IPv6 Address Format

IPv6 increases the length of the address from 32 bits in IPv4 to 128 bits, and therefore has a larger address space than IPv4.

The basic format of an IPv6 address is **X:X:X:X:X:X:X**. The 128-bit IPv6 address is divided into eight 16-bit sections that are separated by colons (:), and 16 bits in each section are represented by four hexadecimal characters (0–9 and A–F). Each **X** represents a 4-character hexadecimal number.

For example: 2001:ABCD:1234:5678:AAAA:BBBB:1200:2100, 800:0:0:0:0:0:1, 1080:0:0:0:8:800:200C:417A

The number **0** in the IPv6 address can be abbreviated as follows:

- The starting 0s can be omitted. For example, 2001:00CD:0034:0078:000A:000B:1200:2100 can be written as 2001:CD:34:78:A:B:1200:2100.
- Consecutive 0s can be replaced by two colons (::). For example, **800:0:0:0:0:0:1** can be written as **800::1**. Consecutive 0s can be replaced by two colons only when the 16-bit section contains all 0s, and the two colons can only appear once in the address.

2. IPv6 Prefix

An IPv6 address consists of two parts:

- Network prefix: It contains n bits, and is equivalent to the network ID in an IPv4 address.
- Interface identifier: It contains (128 - n) bits, and is equivalent to the host ID in an IPv4 address.

The length of the network prefix is separated from the IPv6 address by a slash (/). For example, **12AB::CD30:0:0:0/60** indicates that the length of the prefix used for routing in the address is 60 bits.

3. Special IPv6 Address

There are also some special IPv6 addresses, for example:

fe80::/8 is a link local address, and equivalent to 169.254.0.0/16 in IPv4.

fc00::/7 is a local address, and similar to 10.0.0.0/8, 172.16.0.0/16, or 192.168.0.0/16 in IPv4.

ff00::/12 is a multicast address, and similar to 224.0.0.0/8 in IPv4.

4. N/AT66

IPv6-to-IPv6 Network Address Translation (N/AT66) is the process of converting the IPv6 address in an IPv6 packet header to another IPv6 address. N/AT66 prefix translation is an implementation of N/AT66. It replaces the IPv6 address prefix in the packet header with another IPv6 address prefix to achieve IPv6 address translation. N/AT66 can realize mutual access between an intranet and Internet.

4.16.3 IPv6 Address Assignment Methods

- Manual configuration: The IPv6 address/prefix and other network configuration parameters are manually configured.
- Stateless Address Autoconfiguration (SLAAC): The link local address is generated based on the interface ID, and then the local address is automatically configured based on the prefix information contained in the route advertisement packet.
- Stateful address autoconfiguration, that is, DHCPv6: DHCPv6 is divided into the following two types:
 - DHCPv6 autoconfiguration: The DHCPv6 server automatically configures the IPv6 address/prefix and other network configuration parameters.
 - DHCPv6 Prefix Delegation (PD): The lower-layer network device sends a prefix allocation application to the upper-layer network device. The upper-layer network device assigns an appropriate address prefix to the lower-layer device. The lower-layer device automatically subdivides the obtained prefix (generally less than 64 bits in length) into subnet segments with 64-bit prefix length, and then advertises the

subdivided address prefixes to the user link directly connected to the IPv6 host through the route to realize automatic address configuration of the host.

4.16.4 Enabling IPv6

Choose **One-Device**. Click the device model, and choose **Config > Network > IPv6 Address**.

Click **Enable**, and then click **OK** in the dialog box that appears to enable IPv6.

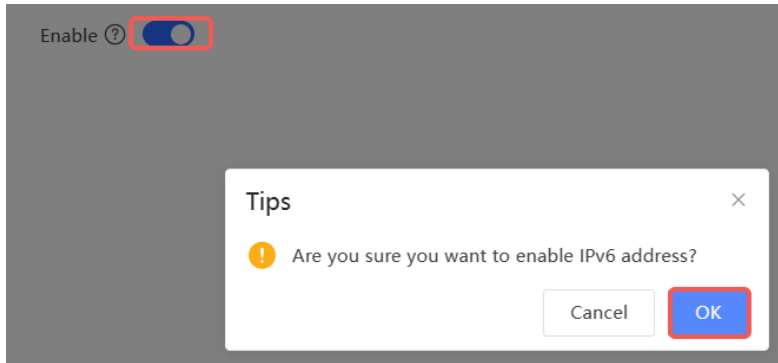

After IPv6 is enabled, you can configure the IPv6 addresses of WAN and LAN ports, view the DHCPv6 client, and configure a static DHCPv6 address for the client.

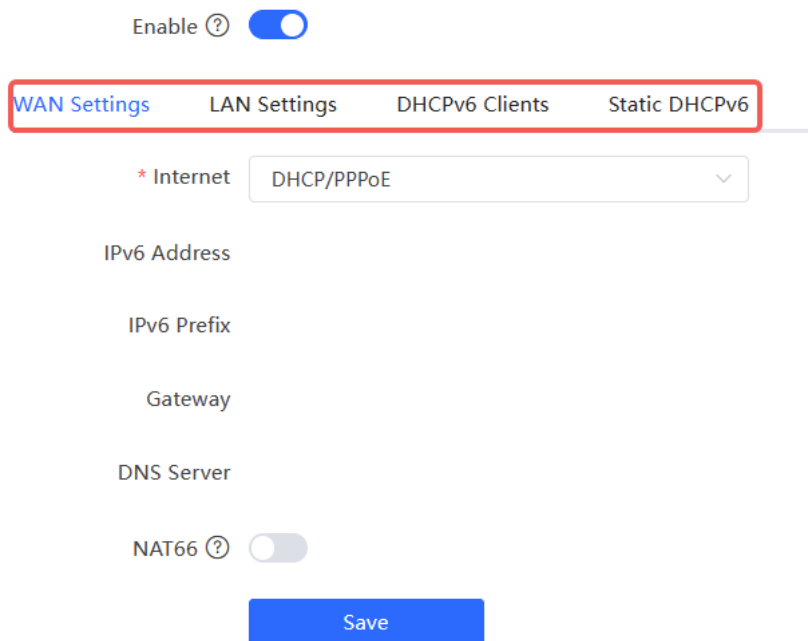

4.16.5 Configuring the IPv6 Address for the WAN Port

Choose **One-Device**. Click the device model, and choose **Config > Network > IPv6 Address > WAN Settings**.

Configure the IPv6 address for the WAN port, and click **Save**.

[WAN Settings](#) LAN Settings DHCPv6 Clients Static DHCPv6

* Internet DHCP/PPPoE

IPv6 Address
 DHCP/PPPoE
 Static IP
 Null

IPv6 Prefix

Gateway

DNS Server

NAT66 ?

Save

Table 4-3 IPv6 Address Configuration Parameters of the WAN Port

Parameter	Description
Internet	Specify the method for obtaining an IPv6 address for the WAN port. <ul style="list-style-type: none"> ● DHCP/PPPoE: The current device will act as a DHCPv6 client and apply for the IPv6 address/prefix from the upstream network device. ● Static IP: If this Internet connection type is selected, you need to manually configure a static IPv6 address, gateway address, and DNS server. ● Null: The IPv6 function is disabled on the current WAN port.
IPv6 Address	If Internet is set to DHCP/PPPoE , the automatically obtained IPv6 address is displayed. If Internet is set to Static IP , you need to manually configure this parameter.
IPv6 Prefix	If Internet is set to DHCP/PPPoE and the current device obtains the IPv6 address prefix from the upstream device. The obtained IPv6 address prefix is displayed.
Gateway	If Internet is set to DHCP/PPPoE , the automatically obtained gateway address is displayed. If Internet is set to Static IP , you need to manually configure this parameter.
DNS Server	If Internet is set to DHCP/PPPoE , the automatically obtained DNS server address is displayed. If Internet is set to Static IP , you need to manually configure this parameter.

Parameter	Description
N/AT66	If the current device cannot access the Internet in DHCP mode or cannot obtain the IPv6 address prefix, you must enable N/AT66 to assign the IPv6 address to an intranet client.

4.16.6 Configuring the IPv6 Address for the LAN Port

Choose **One-Device**. Click the device model, and choose **Config > Network > IPv6 Address > LAN Settings**.

When the device accesses the network in DHCP mode, the upstream device can assign an IPv6 address to the LAN port, and assign IPv6 addresses to the clients in the LAN based on the IPv6 address prefix. If the upstream device cannot assign an IPv6 address prefix to the current device, you need to manually configure an IPv6 address prefix for the LAN port, and assign IPv6 addresses to the clients in the LAN by enabling the N/AT66 function (see [4.16.5 Configuring the IPv6 Address for the WAN Port](#)).

Enable

WAN Settings LAN Settings DHCPv6 Clients Static DHCPv6

LAN Settings

<input type="checkbox"/>	VLAN ID	IPv6 Assignment	Subnet Prefix Name	Subnet ID	Subnet Prefix Length	IPv6 Address/Prefix Length	Action
<input type="checkbox"/>	Default	Auto		0	64		Edit Delete

Up to 8 entries can be added.

Click **Edit** corresponding to the default VLAN, and fill in a local address of no more than 64 bits in the **IPv6 Address/Prefix Length** column. This address will also be used as the IPv6 address prefix.

IPv6 Assignment specifies the method for assigning IPv6 addresses for clients. The following options are available:

- **Auto**: Both DHCPv6 and SLAAC are used to assign IPv6 addresses to clients.
- **DHCPv6**: DHCPv6 is used to assign IPv6 addresses to clients.
- **SLAAC**: SLAAC is used to assign IPv6 addresses to clients.
- **Null**: No IPv6 addresses are assigned to clients.

The setting of **IPv6 Assignment** is determined by the protocol supported by intranet clients. If you are not sure about the protocol supported by intranet clients, select **Auto**.

Edit ×

IPv6 Assignment (?)

IPv6 Address/Prefix Length (?)

You can click **Advanced Settings** to configure more address attributes.

Add ×

* VLAN ID

IPv6 Assignment (?)

IPv6 Address/Prefix

Length (?)

----- [Advanced Settings](#) -----

Subnet Prefix Name (?)

Subnet Prefix Length (?)

Subnet ID (?)

* Lease Time (Min) (?)

DNS Server

Table 4-4 IPv6 Address Configuration Parameters of the LAN Port

Parameter	Description
Subnet Prefix Name	Configure the interface from which the prefix is obtained, for example, WAN_V6 . The default value is all interfaces.
Subnet Prefix Length	Configure the length of the subnet prefix. The value ranges from 48 to 64.
Subnet ID	Configure the subnet ID in hexadecimal notation. 0 indicates that the subnet ID automatically increments.
Lease Time (Min)	Configure the lease term of the IPv6 address. The unit is minutes.
DNS Server	Configure the address of the IPv6 DNS server.

4.16.7 Viewing DHCPv6 Clients

Choose **One-Device**. Click the device model, and choose **Config > Network > IPv6 Address > DHCPv6 Clients**.

When the device acts as a DHCPv6 server to assign IPv6 addresses to clients, you can view information about the clients that obtain IPv6 addresses from the device on the current page. The information includes the host name, IPv6 address, remaining lease term, and DHCPv6 Unique Identifier (DUID) of each client.

Enter an IPv6 address or DUID in the search bar, and click to quickly find the information of the specified DHCPv6 client.

Enable

[WAN Settings](#)
[LAN Settings](#)
[DHCPv6 Clients](#)
[Static DHCPv6](#)

You can view the DHCPv6 clients information on this page.

DHCPv6 Clients [+ Bind Selected](#)

<input type="checkbox"/>	No.	Hostname	IPv6 Address	Remaining Lease Time(min)	DUID	Status
No Data						

Total 0

4.16.8 Configuring the Static DHCPv6 Address

Configure the IPv6 address statically bound to the DUID of a client so that the client can obtain the specified address each time.

Choose **One-Device**. Click the device model, and choose **Config > Network > IPv6 Address > Static DHCPv6**.

Enable

WAN Settings LAN Settings DHCPv6 Clients **Static DHCPv6**

Static IP Address List

No.	IPv6 Address	DUID	Action
No Data			

Up to 200 entries can be added. Total 0

(1) Click **Add**.

Add

* IPv6 Address

* DUID

(2) Enter the IPv6 address and DUID of the client.

(3) Click **OK**.

4.16.9 Configuring the IPv6 Neighbor List

In IPv6, Neighbor Discovery Protocol (NDP) is an important basic protocol. NDP replaces the ARP and ICMP route discovery protocols of IPv4, and supports the following functions: address resolution, neighbor status tracking, duplicate address detection, router discovery, and redirection.

Choose **One-Device**. Click the device model, and choose **Config > Security > IPv6 Neighbor List**.

IPv6 Neighbor List

No.	IPv6 Address	MAC Address	Type	Ethernet status	Action
1	fe80::84ee:eff:fe1c:9ca6	86:ee:0e:1c:9ca6	Dynamic	LAN	Bind
2	fe80::e25d:54ff:fe29:12f1	e0:5d:54:29:12:f1	Dynamic	WAN	Bind
3	fe80::9e8d:50ae:fd73:ac70	7c:a1:77:d0:5c:65	Dynamic	LAN	Bind

Up to 256 entries can be added. Total 3

(1) Click **Add** and add the interface, IPv6 address and MAC address of the neighbor.

Add ✕

*** Interface**

*** IPv6 Address**

*** MAC Address**

(2) Select the IPv6 neighbor list to be bound, and click **Bind** in the **Action** column to bind the IPv6 address and MAC address.

IPv6 Neighbor List Search by IP Address/MAC Addr

<input type="checkbox"/>	No.	IPv6 Address	MAC Address	Type	Ethernet status	Action
<input type="checkbox"/>	1	fe80::84ee:eff:fe1c:9ca6	86:ee:0e:1c:9c:a6	Dynamic	LAN	Bind
<input type="checkbox"/>	2	fe80::e25d:54ff:fe29:12f1	e0:5d:54:29:12:f1	Dynamic	WAN	Bind
<input type="checkbox"/>	3	fe80::9e8d:50aed:f73:ac70	7c:a1:77:d0:5c:65	Dynamic	LAN	Bind

Up to 256 entries can be added. Total 3 10/page

5 Online Client Management

Caution

- When the AP is used as the primary device, clients on the network are only displayed when the AP works in router mode.
- When the AP is used as a secondary device, the functions presented in the web interface are based on the primary device on the network.

Go to the configuration page:

- Choose **Network-Wide > Clients**.
- AP as a secondary device: Choose **One-Device > Config > Clients**.

The client list displays wired and wireless on the current network, including the username, connection mode, associated device, IP/MAC address, IP address binding status, rate, and related operations.

Username	SSID and Band	Signal Quality	Connected To	IP/MAC	Negotiation Rate	Online Duration	LimitSpeed	Action
*	5G	-64db Channel:5G	AP	Not bound	288M	7 minutes 34 seconds	No Limit	Associate Block
DESKTOP-O3SVIQ2	Wired	--	--	Not bound	--	--	--	--

Username	SSID and Band	Connected To	IP/MAC
DESKTOP-O3SVIQ2	Wired	--	Not bound





- Click **Not Bound** in the **IP/MAC** column to bind the client to a static IP address.
- Click a button in the **Action** column to perform the corresponding operation on the online client. Wireless: Associate, and block can be configured.

Note

Client IP binding is only supported when the AP works in router mode.



Table 5-1 Online Client Management Configuration Parameters

Parameter	Description
Username	Name of the connected client.



Parameter	Description
SSID and Band	Indicates the access mode of the client, which can be wireless or wired. The SSID and frequency band is displayed when a client is connected wirelessly.
Signal Quality	The Wi-Fi signal strength of the client and the associated channel. <div style="border: 1px solid black; padding: 5px;"> <p> Note</p> <p>This information is displayed only in the wireless online client list.</p> </div>
Connected To	Indicates wired or wireless connection, the associated device and SN.
IP/MAC	Indicates the IP address and MAC address of the client.
Negotiated Rate	The uplink data rate and downlink data rate of the client. <div style="border: 1px solid black; padding: 5px;"> <p> Note</p> <p>This information is displayed only in the wireless online client list.</p> </div>
Online Duration	Client access duration. <div style="border: 1px solid black; padding: 5px;"> <p> Note</p> <p>This information is displayed only in the wireless online client list.</p> </div>
LimitSpeed	Implement wireless speed limiting for clients to prevent certain clients from consuming large amounts of bandwidth resources. For details, see 5.4 Configuring Client Rate Limiting . <div style="border: 1px solid black; padding: 5px;"> <p> Note</p> <p>This information is displayed only in the wireless online client list.</p> </div>
Action	You can click the corresponding button to perform association and block operations on online clients.



Wired Clients

Click the **Wired** tab to see details about wired clients.

All (2) **Wired (1)** Wireless (1) 
Select  Block  Bind IP

 The client going offline will not disappear immediately. Instead, the client will stay in the list for 3 more minutes.

Username	SSID and Band	Connected To	IP/MAC
DESKTOP-03SVIQ2	 Wired -	--	  Net bound

Total 1  **1**  10/page 

Wireless Clients

Click the **Wireless** tab to see details about wireless clients.

All (2) | Wired (1) | **Wireless (1)** | Select | Block | Bind IP | Search by IP/MAC/Username

The client going offline will not disappear immediately. Instead, the client will stay in the list for 3 more minutes.

Username	SSID and Band	Signal Quality	Connected To	IP/MAC	Negotiation Rate	Online Duration	LimitSpeed	Action
*	5G Channel56	-64db	AP	1 Not bound	288M	7 minutes 34 seconds	No Limit	Associate Block

Total 1 | 1 | 10/page

5.1 Configuring Client IP Binding

Caution

This function is supported only in router mode.

Choose **Network-Wide > Clients**.

IP address binding is a security and access control policy that associates a specific IP address with a specific device or user to achieve identity authentication, access control, monitoring, and accounting.

- Single client IP address binding
Select the client to be bound with an IP address in the list, click **Not bound**, and click **OK** in the pop-up box to bind the client to a static IP address.

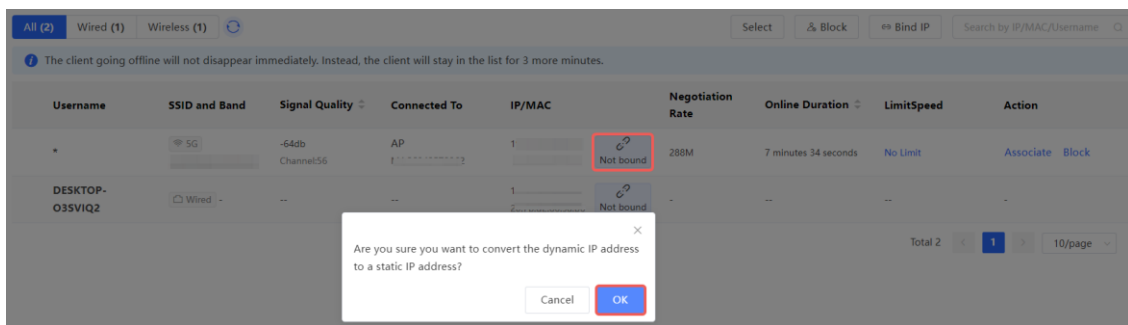

- Batch IP binding
Click **Select**.

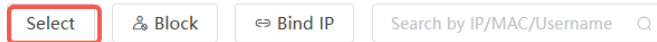

Select the clients to be bound, click **Bind IP**, and click **OK** in the pop-up box to bind the selected clients to a static IP address.

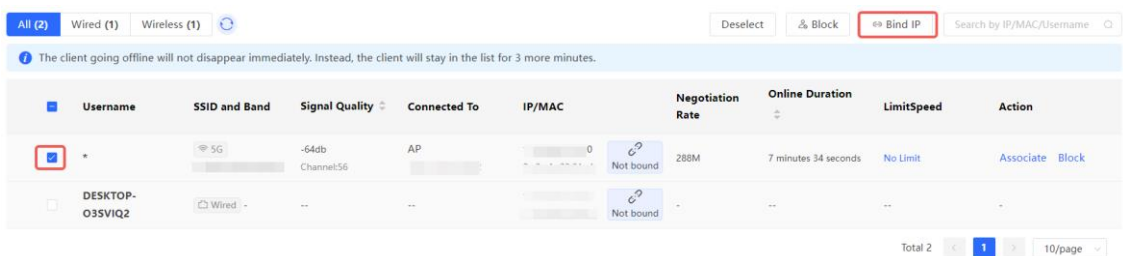

- Unbind an IP address

Select the client to be unbound from the list, click **Bound**, and click **OK** in the pop-up box.

The client going offline will not disappear immediately. Instead, the client will stay in the list for 3 more minutes.

Username	SSID and Band	Signal Quality	Connected To	IP/MAC	Negotiation Rate	Online Duration	LimitSpeed	Action	
*	5G	-64db Channel56	AP	1	Bound	288M	7 minutes 34 seconds	No Limit	Associate Block
DESKTOP-O3SVIQ2	Wired	--	--		Not bound	--	--	--	

Total 2 | 1 | 10/page

5.2 Configuring Client Association

Choose **Network-Wide > Clients**.

Caution

This function applies only to wireless clients.

Select a client in the list and click **Associate** in the **Action** column. You will be redirected to the **Edit Association** page.

The client going offline will not disappear immediately. Instead, the client will stay in the list for 3 more minutes.

Username	SSID and Band	Signal Quality	Connected To	IP/MAC	Negotiation Rate	Online Duration	LimitSpeed	Action	
*	5G	-64db Channel56	AP		Bound	288M	7 minutes 34 seconds	No Limit	Associate Block
DESKTOP-O3SVIQ2	Wired	--	--		Not bound	--	--	--	

Total 2 | 1 | 10/page

The **Client** field is populated with the MAC address of the selected client and cannot be modified. The **Associated Device** field is populated with the associated device of the client by default. Set the SSID and the Forced Association feature as required, and click **OK**. For details, see [3.23 Client Association](#).

Edit Association
✕

* Client 86:ee:0e:1c:9:ca6 ▼

* Associated Device Select ▼

Advanced Settings

SSID Select ▼

Forced Association

Enabling this feature will forcefully associate the client with a specific AP. However, since the client cannot initiate automatic association, this may cause disconnection and unsuccessful association attempts.

Cancel
OK

5.3 Blocking Clients

Choose **Network-Wide > Clients**.

An unauthorized client may occupy network bandwidth and pose security risks. You can block specified clients to solve the unauthorized access problem.

Caution

Client block is available only for wireless clients.

- Block a single client

Select a client to block in the list, click **Block** in the **Action** column, and click **OK** in the pop-up box to block the selected client.

All (2) Wired (1) Wireless (1)
Select Block Bind IP Search by IP/MAC/Username

The client going offline will not disappear immediately. Instead, the client will stay in the list for 3 more minutes.

Username	SSID and Band	Signal Quality	Connected To	IP/MAC	Negotiation Rate	Online Duration	LimitSpeed	Action
-	5G	-71db Channel:56	AP	Bound	36M	15 minutes 5 seconds	No Limit	Associate Block
DESKTOP-O3SVIQ2	Wired	--	--	Not bound	-	--	--	-

Total 2 1 10/page

✕

Do you want to add 86:ee:0e:1c:9:ca6 to the blocklist?

Cancel
OK

- Batch block clients
 - Click **Select**.

b Select the target clients, click **Block**, and click **OK** in the pop-up box to block the selected clients.

The client going offline will not disappear immediately. Instead, the client will stay in the list for 3 more minutes.

<input type="checkbox"/>	Username	SSID and Band	Signal Quality	Connected To	IP/MAC	Negotiation Rate	Online Duration	LimitSpeed	Action
<input checked="" type="checkbox"/>	-	5G Channel:56	-71db	AP		Bound	15 minutes 5 seconds	No Limit	Associate Block
<input type="checkbox"/>	DESKTOP-035VIQ2	Wired	-	-		Not bound	-	-	-

Total 2 10/page

- Cancel block
Choose **Network-Wide > Workspace > Wireless > Blocklist/Allowlist > Global Blocklist/Allowlist**.
Select the client to be removed from the blocklist in the wireless blocklist and click **Delete**.

[Global Blocklist/Allowlist](#)
[SSID-Based Blocklist/Allowlist](#)

All STAs except blocklisted STAs are allowed to access Wi-Fi.
 Only the allowlisted STAs are allowed to access Wi-Fi.

Blocked WLAN Clients

<input type="checkbox"/>	Device Name	MAC Address	Action
<input type="checkbox"/>	M2102J2SC	8:.....:1	Edit <input type="button" value="Delete"/>

Up to 512 members can be added. Total 1 10/page

5.4 Configuring Client Rate Limiting

Choose **Network-Wide > Clients > Wireless**.

To ensure fair resource allocation, the network administrator can implement wireless rate limiting to prevent some users or devices from occupying a large amount of bandwidth and affecting the network experience of other users.

Caution

Rate limiting applies only to wireless clients.

- Configure rate limits for clients
Click the **Wireless** tab, click the **LimitSpeed** column in the table, set the uplink rate limit and downlink rate limit, and click **OK**.

All (2) | Wired (1) | **Wireless (1)**

Deselect | Block | Bind IP | Search by IP/MAC/Username

The client going offline will not disappear immediately. Instead, the client will stay in the list for 3 more minutes.

<input type="checkbox"/>	Username	SSID and Band	Signal Quality	Connected To	IP/MAC	Negotiation Rate	Online Duration	LimitSpeed	Action	
<input type="checkbox"/>	-	5G	-71db Channel:56	AP		Bound	36M	15 minutes 5 seconds	No Limit	Associate Block

Total 1 | 1 | 10/page

LimitSpeed

Uplink Rate Kbps

Limit Current: Kbps. Range: 1-1700000 Kbps

Downlink Rate Kbps

Limit Current: Kbps. Range: 1-1700000 Kbps

Disable Cancel **OK**

- Cancel rate limits
Click the **Wireless** tab, click the **LimitSpeed** column in the table, and click **Disable**.

All (2) | Wired (1) | **Wireless (1)**

Deselect | Block | Bind IP | Search by IP/MAC/Username

The client going offline will not disappear immediately. Instead, the client will stay in the list for 3 more minutes.

<input type="checkbox"/>	Username	SSID and Band	Signal Quality	Connected To	IP/MAC	Negotiation Rate	Online Duration	LimitSpeed	Action	
<input type="checkbox"/>	-	5G	-71db Channel:56	AP		Bound	36M	15 minutes 5 seconds	↑1000Kbps ↓1000Kbps	Associate Block

Total 1 | 1 | 10/page

LimitSpeed

Uplink Rate Kbps

Limit Current: **1000** Kbps. Range: 1-1700000 Kbps

Downlink Rate Kbps

Limit Current: **1000** Kbps. Range: 1-1700000 Kbps

Disable Cancel **OK**

6 System Settings

6.1 PoE Settings

Choose **One-Device**. Click the device model, and choose **Config > Advanced > PoE Settings**.

Set the power mode for the AP to accept power over PoE. In AF mode, the maximum power supported by the device is 15.4 W. In AT mode, the maximum power is 30 W according to the IEEE 802.3at standard. In BT mode, the maximum power is 51 W according to the IEEE 802.3bt standard. By default, the device automatically negotiates with the power sourcing equipment (PSE) about the power mode. The default configuration is recommended.

Power Mode

Current Mode IEEE 802.3at

Energy Saving

Band 2.4G 5G

Current Power 25.5W

6.2 Setting the Login Password

Access the configuration page:

- In self-organizing network mode: Choose **Network-Wide > Workspace > Network-Wide > Password**.
- In standalone mode: Choose **System > Login > Password**.

Enter the old password and new password. After saving the configuration, use the new password to log in.

⚠ Caution

In self-organizing network mode, the login password of all devices in the network will be changed synchronously.

 Change the login password. Please log in again with the new password later.

* Old Password

* New Password

* Confirm Password

6.3 Setting the Session Timeout Duration

Access the configuration page:

- In self-organizing network mode: Choose **One-Device**. Click the device model, and choose **Config > System > Login**.
- In standalone mode: Choose **System > Login > Session Timeout**.

If no operation is performed on the Web page within a period of time, the session is automatically disconnected. When you need to perform operations again, enter the password to log in again. The default timeout duration is 3600 seconds, that is, 1 hour.

* Session Timeout  seconds

6.4 Setting and Displaying System Time

Access the configuration page:

- In self-organizing network mode: Choose **Network-Wide > System > System Time**.
- In standalone mode: Choose **System > System Time**.

You can view the current system time. If the time is incorrect, check and select the local time zone. If the time zone is correct but time is still incorrect, click **Edit** to manually set the time. In addition, the device supports Network Time Protocol (NTP) servers. By default, multiple servers serve as the backup of each other. You can add or delete the local server.

 **Caution**

In self-organizing network mode, the system time of all devices in the network will be changed synchronously.

i Configure and view system time (the device has no RTC module, and time settings are not saved upon restart).

Current Time ? 2023-12-13 10:22:54 Edit

* Time Zone (GMT+8:00)Asia/Shanghai ▼

* NTP Server ?

0.cn.pool.ntp.org	Add
1.cn.pool.ntp.org	Delete
cn.pool.ntp.org	Delete
pool.ntp.org	Delete
asia.pool.ntp.org	Delete
europa.pool.ntp.org	Delete
ntp1.aliyun.com	Delete

Save

6.5 Configuring SNMP

6.5.1 Overview

The Simple Network Management Protocol (SNMP) is a protocol for managing network devices. Based on the client/server model, it can achieve remote monitoring and control of network devices.

SNMP uses a manager and agent architecture. The manager communicates with agents through the SNMP protocol to retrieve information such as device status, configuration details, and performance data. It can also be used to configure and manage devices.

SNMP can be used to manage various network devices, including routers, switches, servers, firewalls, etc. You can achieve user management through the SNMP configuration interface and monitor and control devices through the third-party software.

6.5.2 Global Configuration

1. Overview

The purpose of global configuration is to enable the SNMP service and make the SNMP protocol version (v1/v2c/v3) take effect, so as to achieve basic configuration of local port, device location, and contact information.

SNMP v1: As the earliest version of SNMP, SNMP v1 has poor security, and only supports simple community string authentication. SNMP v1 has certain flaws, such as plaintext transmission of community strings and vulnerability to attacks. Therefore, SNMP v1 is not recommended for modern networks.

SNMP v2c: As an improved version of SNMP v1, SNMP v2c supports richer functions and more complex data types, with enhanced security. SNMP v2c performs better than SNMP v1 in terms of security and functionality, and is more flexible. It can be configured according to different needs.

SNMP v3: As the newest version, SNMP v3 supports security mechanisms such as message authentication and encryption compared to SNMP v1 and SNMP v2c. SNMP v3 has achieved significant improvements in security and access control.

2. Configuration Steps

Choose **Network-Wide > Workspace > Network-Wide > SNMP > Global Config**.

(1) Enable the SNMP service.

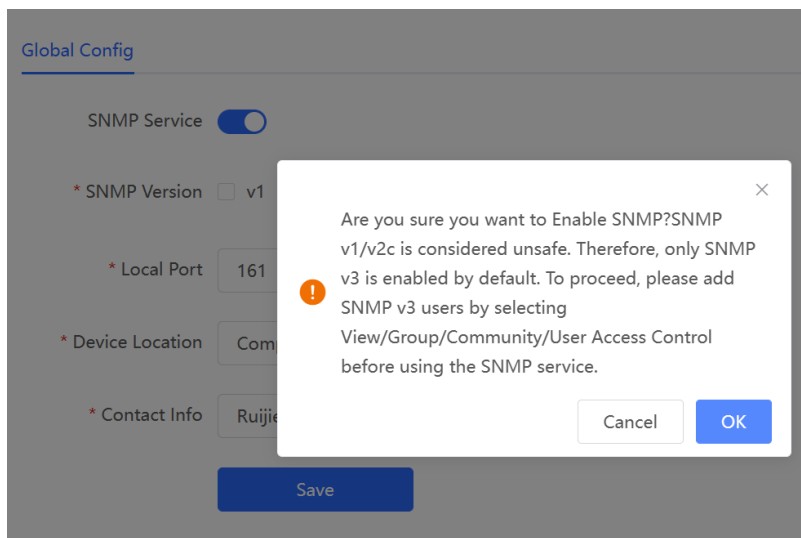

When it is enabled for the first time, SNMP v3 is enabled by default. Click **OK**.

(2) Set SNMP service global configuration parameters.

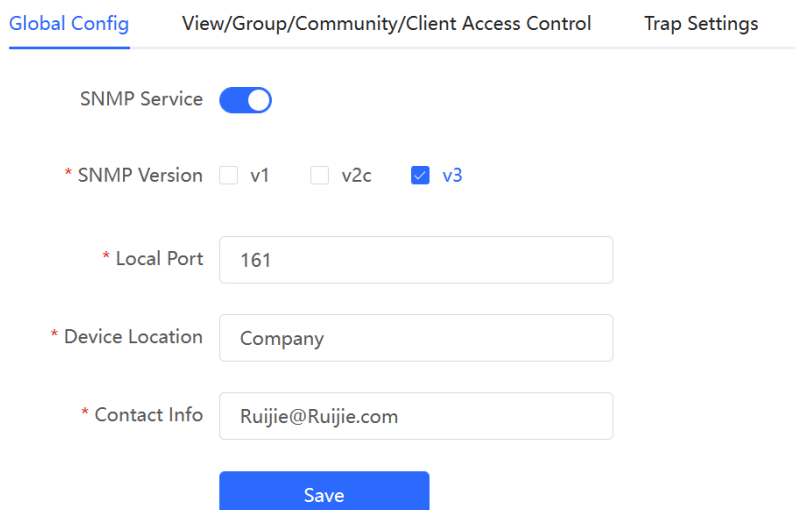

Table 6-1 Global Configuration Parameters

Parameter	Description
SNMP Service	Indicates whether SNMP service is enabled.
SNMP Version	Indicates the SNMP protocol version, including v1, v2c, and v3 versions.
Local Port	The port range is 1 to 65535.
Device Location	1-64 characters. Chinese characters, full-width characters, question marks, and spaces are not allowed.
Contact Info	1-64 characters. Chinese characters, full-width characters, question marks, and spaces are not allowed.

(3) Click **Save**.

After the SNMP service is enabled, click **Save** to make basic configurations such as the SNMP protocol version number take effect.

6.5.3 View/Group/Community/User Access Control

1. Configuring Views

- Overview

Management Information Base (MIB) can be regarded as a database storing the status information and performance data of network devices. It contains a large number of object identifiers (OIDs) to identify the status information and performance data of these network devices.

Views in SNMP can limit the range of MIB nodes that the management system can access, thereby improving the security and reliability of network management. Views are an indispensable part of SNMP and need to be configured or customized according to specific management requirements.

A view can have multiple subtrees. The management system can only access MIB nodes in these subtrees, and cannot access other unauthorized MIB nodes. This can prevent unauthorized system administrators from accessing sensitive MIB nodes, thereby protecting the security of network devices. Moreover, views can also improve the efficiency of network management and speed up the response from the management system.

- Configuration Steps

Choose **Network-Wide > Workspace > Network-Wide > SNMP > View/Group/Community/Client Access Control > View List**.

(1) Click **Add** under the View List to add a view.

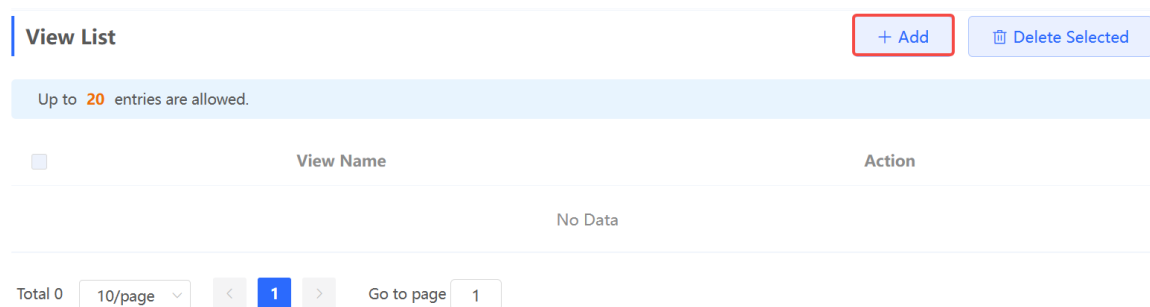

(2) Configure basic information of a view.

Add
×

* View Name

OID

Add Included Rule
Add Excluded Rule

Rule/OID List
Delete Selected

Up to **100** entries are allowed.

	Rule	OID	Action
No Data			

Total 0

<
1
>

Go to page

Cancel
OK

Table 6-2 View Configuration Parameters

Parameter	Description
View Name	Indicates the name of the view. 1-32 characters. Chinese or full width characters are not allowed.
OID	Indicates the range of OIDs included in the view, which can be a single OID or a subtree of OIDs.
Type	There are two types of rules: included and excluded rules. <ul style="list-style-type: none"> ● The included rule only allows access to OIDs within the OID range. Click Add Included Rule to set this type of view. ● Excluded rules allow access to all OIDs except those in the OID range. Click Add Excluded Rule to configure this type of view.

Note

A least one OID rule must be configured for a view. Otherwise, an alarm message will appear.

(3) Click **OK**.

2. Configuring v1/v2c Users

- Overview

When the SNMP version is set to v1/v2c, user configuration is required.

Global Config

SNMP Service

* SNMP Version v1 v2c v3

* Local Port

* Device Location

* Contact Info

Note

Select the SNMP protocol version, and click **Save**. The corresponding configuration options will appear on the **View/Group/Community/User Access Control** page.

- Configuration Steps

Choose **Network-Wide > Workspace > Network-Wide > SNMP > View/Group/Community/Client Access Control > SNMP v1/v2c Community Name List**.

(1) Click **Add** in the **SNMP v1/v2c Community Name List** pane.

Global Config [View/Group/Community/Client Access Control](#) Trap Settings

SNMP v1/v2c Community Name List + Add

Up to 20 entries are allowed.

<input type="checkbox"/>	Community Name	Access Mode	MIB View	Action
No Data				

Total 0

(2) Add a v1/v2c user.

Add
×

* Community Name

* Access Mode Read-Only ▾

* MIB View all ▾ [Add View +](#)

Cancel
OK

Table 6-3 v1/v2c User Configuration Parameters

Parameter	Description
Community Name	At least 8 characters. It must contain at least three character categories, including uppercase and lowercase letters, digits, and special characters. Admin, public or private community names are not allowed. Question marks, spaces, and Chinese characters are not allowed.
Access Mode	Indicates the access permission (read-only or read & write) for the community name.
MIB View	The options under the drop-down box are configured views (default: all, none).

⚠ Caution

- Community names cannot be the same among v1/v2c users.
 - Click **Add View** to add a view.
-

(3) Click **OK**.

3. Configuring v3 Groups

- Overview

SNMP v3 introduces the concept of grouping to achieve better security and access control. A group is a group of SNMP users with the same security policies and access control settings. With SNMP v3, multiple groups can be configured, each with its own security policies and access control settings. Each group can have one or more users.

- Prerequisites

When the SNMP version is set to v3, the v3 group configuration is required.

SNMP Service

* SNMP Version v1 v2c v3

* Local Port

* Device Location

* Contact Info

Note

Select the SNMP protocol version, and click **Save**. The corresponding configuration options will appear on the **View/Group/Community/User Access Control** page.

● Configuration Steps

Choose **Network-Wide > Workspace > Network-Wide > SNMP > View/Group/Community/Client Access Control > SNMP v3 Group List**.

(1) Click **Add** in the **SNMP v3 Group List** pane to create a group.

Global Config View/Group/Community/Client Access Control Trap Settings

SNMP v3 Group List

Up to 20 entries are allowed.

<input type="checkbox"/>	Group Name	Security Level	Read-Only View	Read & Write View	Notification View	Action
<input type="checkbox"/>	default_group	Auth & Security	all	none	none	Edit Delete

Total 1 Go to page

(2) Configure v3 group parameters.

Add
×

* Group Name

* Security Level Allowlist & Security ▾

* Read-Only View all ▾ [Add View +](#)

* Read & Write View all ▾ [Add View +](#)

* Notification View none ▾ [Add View +](#)

Cancel
OK

Table 6-4 v3 Group Configuration Parameters

Parameter	Description
Group Name	Indicates the name of the group. 1-32 characters. Chinese characters, full-width characters, question marks, and spaces are not allowed.
Security Level	Indicates the minimum security level (authentication and encryption, authentication but no encryption, no authentication and encryption) of the group.
Read-Only View	The options under the drop-down box are configured views (default: all, none).
Read & Write View	The options under the drop-down box are configured views (default: all, none).
Notification View	The options under the drop-down box are configured views (default: all, none).

⚠ Caution

- A group defines the minimum security level, read and write permissions, and scope for users within the group.
- The group name must be unique. To add a view, click **Add View**.

(3) Click **OK**.

4. Configuring v3 Users

- Prerequisites

When the SNMP version is set to v3, the v3 group configuration is required.

Global Config View/Group/Community/Client Access Control Trap Settings

SNMP Service

* SNMP Version v1 v2c v3

* Local Port

* Device Location

* Contact Info

Note

Select the SNMP protocol version, and click **Save**. The corresponding configuration options will appear on the **View/Group/Community/User Access Control** page.

- Configuration Steps

Choose **Network-Wide > Workspace > Network-Wide > SNMP > View/Group/Community/Client Access Control > SNMP v3 Client List**.

(1) Click **Add** in the **SNMP v3 Client List** pane to add a v3 user.

Global Config View/Group/Community/Client Access Control Trap Settings

SNMP v3 Client List

Up to 50 entries are allowed.

<input type="checkbox"/>	Username	Group Name	Security Level	Auth Protocol	Auth Password	Encryption Protocol	Encrypted Password	Action
No Data								

Total 0

(2) Configure v3 user parameters.

Add
×

* Username

* Group Name

* Security Level

* Auth Protocol * Auth Password

* Encryption Protocol * Encrypted Password

Table 6-5 v3 User Configuration Parameters

Parameter	Description
Username	Username At least 8 characters. It must contain at least three character categories, including uppercase and lowercase letters, digits, and special characters. Admin, public or private community names are not allowed. Question marks, spaces, and Chinese characters are not allowed.
Group Name	Indicates the group to which the user belongs.
Security Level	Indicates the security level (authentication and encryption, authentication but no encryption, and no authentication and encryption) of the user.
Auth Protocol, Auth Password	Authentication protocols supported: MD5/SHA/SHA224/SHA256/SHA384/SHA512. Authentication password: 8-31 characters. Chinese characters, full-width characters, question marks, and spaces are not allowed. It must contain at least three character categories, including uppercase and lowercase letters, digits, and special characters. Note: This parameter is mandatory when the security level is authentication and encryption, or authentication but no encryption.

Parameter	Description
Encryption Protocol, Encrypted Password	<p>Encryption protocols supported: DES/AES/AES192/AES256.</p> <p>Encryption password: 8-31 characters. Chinese characters, full-width characters, question marks, and spaces are not allowed.</p> <p>It must contain at least three character categories, including uppercase and lowercase letters, digits, and special characters.</p> <p>Note: This parameter is mandatory when the security level is authentication and encryption.</p>

⚠ Caution

- The security level of v3 users must be greater than or equal to that of the group.
- There are three security levels, among which authentication and encryption requires the configuration of authentication protocol, authentication password, encryption protocol, and encryption password. Authentication but no encryption only requires the configuration of authentication protocol and encryption protocol, while no authentication and encryption does not require any configuration.

5. Viewing v3 Device Identifier

Choose **Network-Wide > Workspace > Network-Wide > SNMP > View/Group/Community/Client Access Control > SNMP v3 Device Identifier List.**

View the v3 device identifier in the **SNMP v3 Device Identifier List** pane.

SNMP v3 Device Identifier List ▼

No.	Device Model	IP	engineID	Action
1			80 	Copy

Total 1 10/page ▼ < 1 > Go to page 1

6.5.4 SNMP Service Typical Configuration Examples

1. Configuring SNMP v2c

- Application Scenario

You only need to monitor the device information, but do not need to set and deliver it. A third-party software can be used to monitor the data of nodes like 1.3.6.1.2.1.1 if v2c version is configured.

- Configuration Specification

According to the user's application scenario, the requirements are shown in the following table:

Table 6-6 User Requirement Specification

Item	Description
View range	Included rule: the OID is .1.3.6.1.2.1.1, and the custom view name is "system".
Version	For SNMP v2c, the custom community name is "Ruijie_com", and the default port number is 161.
Read & write permission	Read-only permission.

- Configuration Steps

(1) In the global configuration interface, select v2c and set other settings as default. Then, click **Save**.

[Global Config](#) [View/Group/Community/Client Access Control](#) [Trap Settings](#)

SNMP Service

* SNMP Version v1 v2c v3

* Local Port

* Device Location

* Contact Info

(2) Add a view on the **View/Group/Community/Client Access Control** interface.

- a Click **Add** in the **View List** pane to add a view.
- b Enter the view name and OID in the pop-up window, and click **Add Included Rule**.
- c Click **OK**.

Add
×

* View Name

OID

Add Included Rule
Add Excluded Rule

Rule/OID List

Delete Selected

Up to **100** entries are allowed.

<input type="checkbox"/>	Rule	OID	Action
No Data			

Total 0 < 1 > Go to page

Cancel
OK

- (3) On the View/Group/Community/Client Access Control interface, enter the SNMP v1/v2c community name.
 - a Click **Add** in the **SNMP v1/v2c Community Name List** pane.
 - b Enter the group name, access mode, and view in the pop-up window.
 - c Click **OK**.

Add
×

* Community Name

* Access Mode

* MIB View Add View +

Cancel
OK

2. Configuring SNMP v3

- Application Scenario

You need to monitor and control devices, and use the third-party software to monitor and deliver device information to public nodes (1.3.6.1.2.1). The security level of v3 is authentication and encryption.

- Configuration Specification

According to the user's application scenario, the requirements are shown in the following table:

Table 6-7 User Requirement Specification

Item	Description
View range	Included rule: the OID is .1.3.6.1.2.1, and the custom view name is "public_view".
Group configuration	Group name: group Security level: authentication and encryption Select public_view for a read-only view. Select public_view for a read & write view. Select none for a notify view.
Configuring v3 Users	User name: v3_user Group name: group Security level: authentication and encryption Authentication protocol/password: MD5/Ruijie123 Encryption protocol/password: AES/Ruijie123
Version	For SNMP v3, the default port number is 161.

● Configuration Steps

- (1) On the global configuration interface, select v3, and change the port number to 161. Set other settings to defaults. Then, click **Save**.

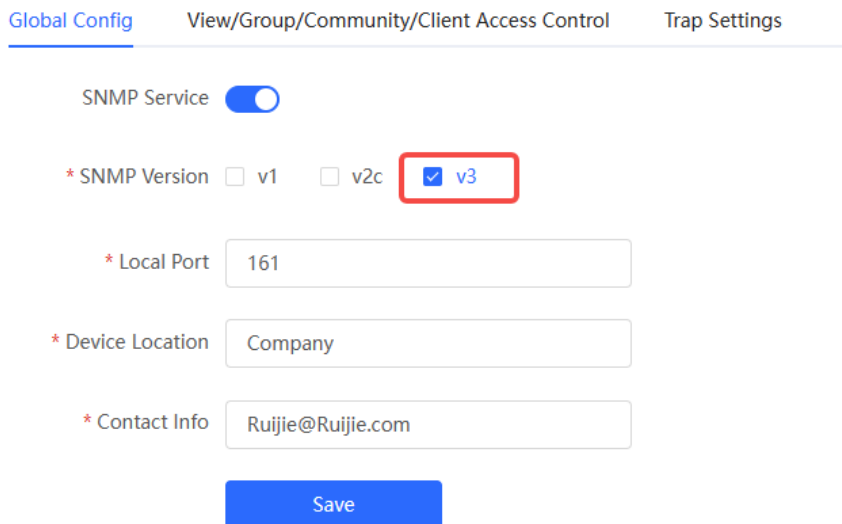

- (2) Add a view on the **View/Group/Community/Client Access Control** interface.
 - a Click **Add** in the **View List** pane.
 - b Enter the view name and OID in the pop-up window, and click **Add Included Rule**.
 - c Click **OK**.

Add
×

* View Name

OID

Add Included Rule
Add Excluded Rule

Rule/OID List Delete Selected

Up to 100 entries are allowed.

	Rule	OID	Action
No Data			

Total 0 < 1 > Go to page

Cancel
OK

- (3) On the **View/Group/Community/Client Access Control** interface, add an SNMP v3 group.
 - a Click **Add** in the **SNMP v3 Group List** pane.
 - b Enter the group name and security level on the pop-up window. As this user has read and write permissions, select `public_view` for read-only and read & write views, and select none for notify views.
 - c Click **OK**.

Add
×

* Group Name

* Security Level

* Read-Only View Add View +

* Read & Write View Add View +

* Notification View Add View +

Cancel
OK

- (4) On the **View/Group/Community/Client Access Control** interface, add an SNMP v3 user.
 - a Click **Add** in the **SNMP v3 Client List** pane.
 - b Enter the user name and group name in the pop-up window. As the user's security level is authentication and encryption, enter the authentication protocol, authentication password, encryption protocol, and encryption password.
 - c Click **OK**.

Add ×

* Username

* Group Name

* Security Level

* Auth Protocol * Auth Password

* Encryption Protocol * Encrypted Password

6.5.5 Configuring Trap Service

Trap is a notification mechanism of the Simple Network Management Protocol (SNMP) protocol. It is used to report the status and events of network devices to administrators, including device status, faults, performance, configuration, and security management. Trap provides real-time network monitoring and fault diagnosis services, helping administrators discover and solve network problems in a timely manner.

1. Enabling Trap Service

Enable the trap service and select the effective trap version, including v1, v2c, and v3 versions.

Choose **Network-Wide > Workspace > Network-Wide > SNMP > Trap Settings**.

(1) Enable the trap service.

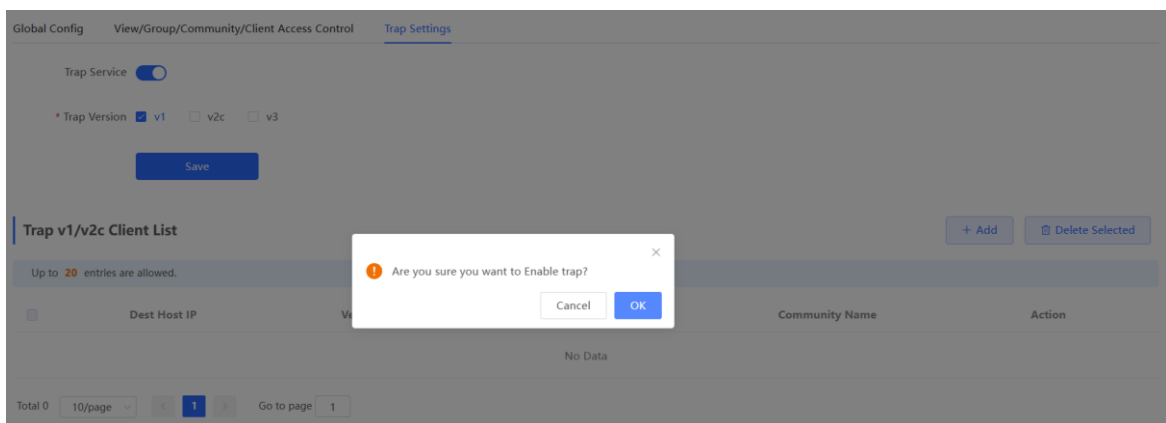

When the trap service is enabled for the first time, the system will pop up a prompt message. Click **OK**.

(2) Set the trap version.

The trap versions include v1, v2c, and v3.

(3) Click **Save**.

After the trap service is enabled, click **Save** for the configuration to take effect.

Trap Service

* Trap Version v1 v2c v3

Save

2. Configuring Trap v1/v2c Users

- Overview

Trap is a notification mechanism that is used to send alerts to administrators when important events or failures occur on devices or services. Trap v1/v2c are two versions in the SNMP protocol for network management and monitoring.

Trap v1 is the first version that supports basic alert notification functionality. Trap v2c is the second version, which supports more alert notification options and advanced security features.

By using trap v1/v2c, administrators can promptly understand problems on the network and take corresponding measures.

- Prerequisites

Once trap v1 and v2c versions are selected, it is necessary to add trap v1/v2c users.

- Configuration Steps

Choose **Network-Wide > Workspace > Network-Wide > SNMP > Trap Settings**.

(1) Click **Add** in the **Trap v1/v2c Client List** pane to add a trap v1/v2c user.

Global Config View/Group/Community/Client Access Control Trap Settings

Trap Service

* Trap Version v1 v2c v3

Save

Trap v1/v2c Client List + Add Delete Selected

Up to 20 entries are allowed.

<input type="checkbox"/>	Dest Host IP	Version Number	Port ID	Community Name	Action
No Data					

Total 0

(2) Configure trap v1/v2c user parameters.

Add
×

* Dest Host IP

* Version Number

* Port ID

* Community

Name/Username

Table 6-8 Trap v1/v2c User Configuration Parameters

Parameter	Description
Dest Host IP	IP address of the trap peer device. An IPv4 or IPv6 address is supported.
Version Number	Trap version, including v1 and v2c.
Port ID	The port range of the trap peer device is 1 to 65535.
Community Name/Username	Community name of the trap user. At least 8 characters. It must contain at least three character categories, including uppercase and lowercase letters, digits, and special characters. Admin, public or private community names are not allowed. Question marks, spaces, and Chinese characters are not allowed.

⚠ Caution

- The destination host IP address of trap v1/ v1/v2c users cannot be the same.
- Community names of trap v1/ v1/v2c users cannot be the same.

(3) Click **OK**.

3. Configuring Trap v3 Users

- Overview

Trap v3 is a network management mechanism based on the SNMP protocol. It is used to send alert notifications to administrators. Unlike previous versions, trap v3 provides more secure and flexible configuration options, including authentication and encryption features.

Trap v3 offers custom conditions and methods for sending alerts, as well as the recipients and notification methods for receiving alerts. This enables administrators to have a more accurate understanding of the status of network devices and to take timely measures to ensure the security and reliability of the network.

- Prerequisites

When the v3 version is selected for the trap service, it is necessary to add a trap v3 user.

- Configuration Steps

Choose **Network-Wide > Workspace > Network-Wide > SNMP > Trap Settings**.

(1) Click **Add** in the **Trap v3 Client List** pane to add a trap v3 user.

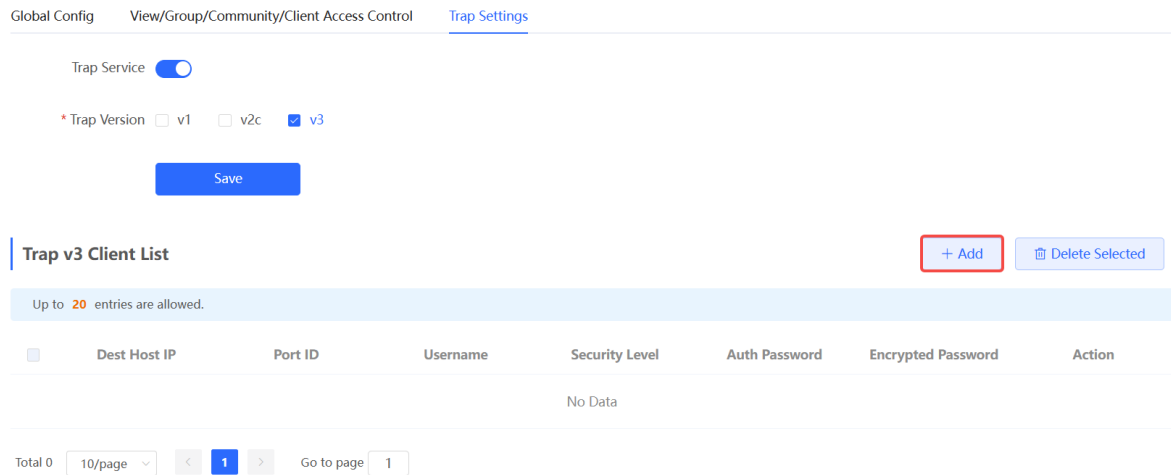

(2) Configure trap v3 user parameters.

Add ✕

<p>* Dest Host IP <input style="width: 90%;" type="text" value="Support IPv4/IPv6"/></p> <p>* Username <input style="width: 90%;" type="text"/></p> <p>* Auth Protocol <input style="width: 90%;" type="text" value="MD5"/></p> <p>* Encryption Protocol <input style="width: 90%;" type="text" value="AES"/></p>	<p>* Port ID <input style="width: 90%;" type="text"/></p> <p>* Security Level <input style="width: 90%;" type="text" value="Auth & Security"/></p> <p>* Auth Password <input style="width: 90%;" type="text"/></p> <p>* Encrypted Password <input style="width: 90%;" type="text"/></p>
---	---

Table 6-9 Trap v3 User Configuration Parameters

Parameter	Description
Dest Host IP	IP address of the trap peer device. An IPv4 or IPv6 address is supported.
Port ID	The port range of the trap peer device is 1 to 65535.

Parameter	Description
Username	<p>Name of the trap v3 user.</p> <p>At least 8 characters.</p> <p>It must contain at least three character categories, including uppercase and lowercase letters, digits, and special characters.</p> <p>Admin, public or private community names are not allowed.</p> <p>Question marks, spaces, and Chinese characters are not allowed.</p>
Security Level	<p>There are three security levels for a trap user, which are "Auth & Security", "Auth & Open", and "Allowlist & Security".</p>
Auth Protocol, Auth Password	<p>Authentication protocols supported: MD5/SHA/SHA224/SHA256/SHA384/SHA512.</p> <p>Authentication password: 8-31 characters. Chinese characters, full-width characters, question marks, and spaces are not allowed. It must contain at least three character categories, including uppercase and lowercase letters, digits, and special characters.</p> <p>Note: This parameter must be set when the Security Level is Auth & Security or Auth & Open.</p>
Encryption Protocol, Encrypted Password	<p>Encryption protocols supported: DES/AES/AES192/AES256.</p> <p>Encryption password: 8-31 characters. Chinese characters, full-width characters, question marks, and spaces are not allowed.</p> <p>It must contain at least three character categories, including uppercase and lowercase letters, digits, and special characters.</p> <p>Note: This parameter must be set when the Security Level is Auth & Security.</p>

 **Caution**

The destination host IP address of trap v1/v2c/v3 users cannot be the same.

(3) Click **OK**.

6.5.6 Trap Service Typical Configuration Examples

1. Configuring Trap v2c

- Application Scenarios

During device monitoring, if the device is suddenly disconnected or encounters an abnormality, and the third-party monitoring software cannot detect and handle the abnormal situation in a timely manner, you can configure the device with a destination IP address of 192.168.110.85 and a port number of 166 to enable the device to send a v2c trap in case of an abnormality.

- Configuration Specification

According to the user's application scenario, the requirements are shown in the following table:

Table 6-10 User Requirement Specification

Item	Description
IP address and port number	The destination host IP is 192.168.110.85, and the port number is 166.
Version	Select the v2c version.
Community name/User name	Trap_ruijie

- Configuration Steps

(1) Select the v2c version in the **Trap Setting** interface and click **Save**.

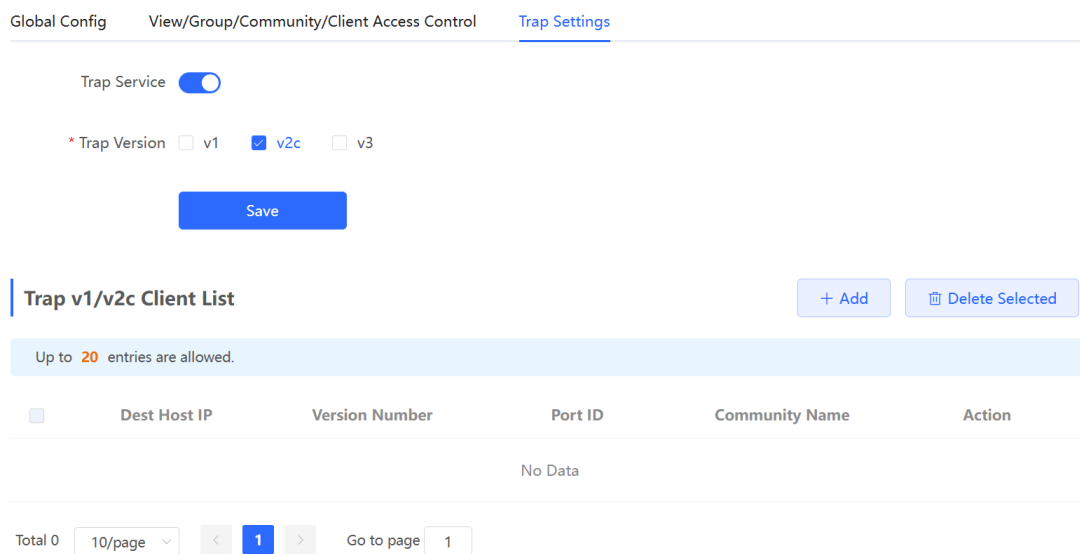

(2) Click **Add** in the Trap v1/v2c Client List to add a trap v2c user.

(3) Enter the destination host IP address, version, port number, user name, and other information. Then, click **OK**.

Add
×

* Dest Host IP

* Version Number

* Port ID

* Community

Name/Username

2. Configuring Trap v3

- Application Scenarios

During device monitoring, if the device is suddenly disconnected or encounters an abnormality, and the third-party monitoring software cannot detect and handle the abnormal situation in a timely manner, you can configure the device with a destination IP address of 192.168.110.87 and a port number of 167 to enable the device to send a v3 trap, which is a safer trap compared with v1/v2c traps.

- Configuration Specification

According to the user's application scenario, the requirements are shown in the following table:

Table 6-11 User Requirement Specification

Item	Description
IP address and port number	The destination host IP is 192.168.110.87, and the port number is 167.
Version and user name	Select the v3 version and trapv3_ ruijie for the user name.
Authentication protocol/authentication password	Authentication protocol/password: MD5/Ruijie123
Encryption protocol/encryption password	Encryption protocol/password: AES/Ruijie123

- Configuration Steps

(1) Select the v3 version in the **Trap Setting** interface and click **Save**.

Global Config View/Group/Community/Client Access Control **Trap Settings**

Trap Service

* Trap Version v1 v2c v3

Save

Trap v3 Client List + Add Delete Selected

Up to 20 entries are allowed.

<input type="checkbox"/>	Dest Host IP	Port ID	Username	Security Level	Auth Password	Encrypted Password	Action
No Data							

Total 0 Go to page

- (2) Click **Add** in the Trap v3 Client List to add a trap v3 user.
- (3) Enter the destination host IP address, port number, user name, and other information. Then, click **OK**.

Add ×

* Dest Host IP	<input type="text" value="192.168.110.87"/>	* Port ID	<input type="text" value="167"/>
* Username	<input type="text" value="trapv3_ruijie"/>	* Security Level	<input type="text" value="Auth & Security"/>
* Auth Protocol	<input type="text" value="MD5"/>	* Auth Password	<input type="text" value="Ruijie123"/>
* Encryption Protocol	<input type="text" value="AES"/>	* Encrypted Password	<input type="text" value="Ruijie123"/>

6.6 Configuring Reboot

Caution

- Do not cut off power during system reboot to avoid device damage.
- Do not refresh the page or close the browser during the reboot. After the device is successfully rebooted and the Web service becomes available, the device automatically jumps to the login page.
- Rebooting the device affects the network. Therefore, exercise caution when performing this operation.

6.6.1 Rebooting the Master Device

In self-organizing network mode:

- Choose **Network-Wide > System > Reboot**. Click the **Reboot** tab and select **master device**.
- Choose **Network-Wide > Workspace > Network-Wide > Reboot**. Click the **Reboot** tab and select **master**

device.

Click the **Reboot** button. The master device will restart.

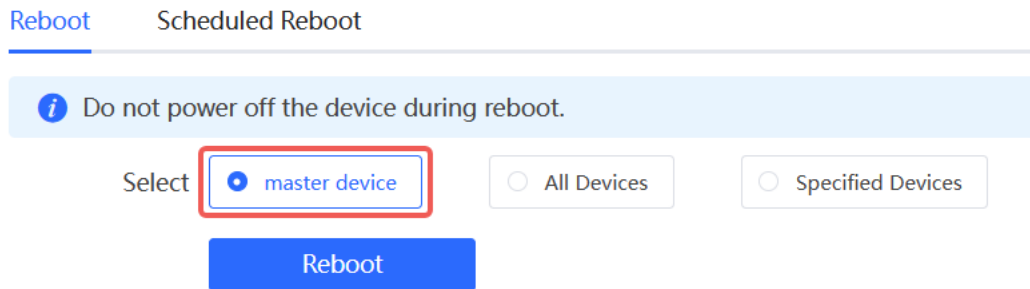

6.6.2 Rebooting Local Device

- In self-organizing network mode, choose **One-Device**. Click the device model, and choose **Config > System > Reboot**.

Click the **Reboot** button. The device will restart.

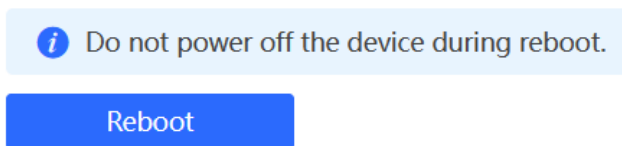

- In standalone mode: choose **System > Reboot > Reboot**.

Click the **Reboot** button. The device will restart.

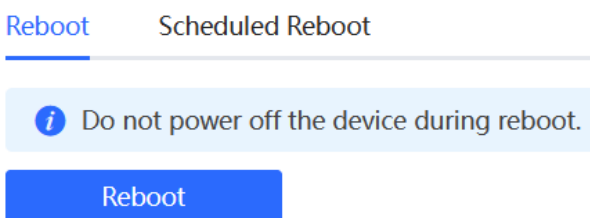

6.6.3 Rebooting All Devices on the Network

In self-organizing network mode, you can batch reboot all devices on the network.

Access the configuration page:

- Choose **Network-Wide > System > Reboot**. Click the **Reboot** tab and select **All Devices**.
- Choose **Network-Wide > Workspace > Network-Wide > Reboot**. Click the **Reboot** tab and select **All Devices**.

Click the **Reboot** button to batch reboot all devices on the network.

Reboot Scheduled Reboot

i Do not power off the device during reboot.

Select master device All Devices Specified Devices

Reboot

⚠ Caution
 It takes time to reboot all devices in the current network. The action may affect the whole network. Please be cautious.

6.6.4 Rebooting the Specified Devices

In self-organizing network mode, you can reboot specified devices in the network in batches. Access the configuration page:

- Choose **Network-Wide > System > Reboot**. Click the **Reboot** tab and select **Specified Devices**.
- Choose **Network-Wide > Workspace > Network-Wide > Reboot**. Click the **Reboot** tab and select **Specified Devices**.

Select required devices from the **Available Devices** list, and click **Add** to add devices to the **Selected Devices** on the right.

Reboot Scheduled Reboot

i Do not power off the device during reboot.

Select master device All Devices Specified Devices

Available Devices 2/53

Q Search by SN/Model

- G1SK7QL171654 - RAP2260
- CAP70CB017868 - EG210G-P
- ZASLA5Q00065A - RAP1261(E)
- ZASLA5Q000808 - RAP1261(E)
- ZASLA5Q000622 - RAP1261(E)
- G1PQ5AM05312A - RAP2200(E)

Reboot

Selected Devices 0/0

Q Search by SN/Model

No data

< Delete **Add** >

Click the **Reboot** button. Specified devices in the **Selected Devices** list will be rebooted.

Reboot Scheduled Reboot

i Do not power off the device during reboot.

Select master device All Devices Specified Devices

Available Devices 0/51

Q Search by SN/Model

- ZASLA5Q00065A - RAP1261(E)
- ZASLA5Q000808 - RAP1261(E)
- ZASLA5Q000622 - RAP1261(E)
- G1PQ5AM05312A - RAP2200(E)
- G1SK7N7000748 - EAP262(E)
- G1QH2LQ000238 - EAP162(G)

< Delete

Add >

Selected Devices 2/2

Q Search by SN/Model

- G1SK7QL171654 - RAP2260
- CAP70CB017868 - EG210G-P

Reboot

6.7 Configuring Scheduled Reboot

Confirm that the system time is accurate to avoid network interruption caused by device reboot at wrong time. For details about how to configure the system time, see [6.4 Setting and Displaying System Time](#).

Access the configuration page:

- Choose **Network-Wide > System > Reboot > Scheduled Reboot**.
- Choose **Network-Wide > Workspace > Network-Wide > Reboot > Scheduled Reboot**.

⚠ Caution

If you configure scheduled reboot on the management webpage, all devices will restart when the system time matches with the scheduled reboot time. Please be cautious.

Click **Scheduled Reboot**, and select the date and time of scheduled reboot every week. Click **Save**. When the system time matches with the scheduled reboot time, the device will restart. You are recommended to set scheduled reboot time to off-peak hours.

Reboot Scheduled Reboot

1. After this feature is enabled, the device will reboot at the scheduled time.

i 2. You are advised to set the scheduled reboot time in the early morning or other service idle time.

Note: When the upstream device is rebooted at the scheduled time, all downstream devices connected to it will also be rebooted.

Scheduled Reboot

Repeats on Mon Tue Wed Thu Fri Sat Sun

Reboot Time :

Save

6.8 Configuring Backup and Import

Access the configuration page:

- Choose **Network-Wide > System > Backup & Import**.
- Choose **One-Device**. Click the device model, and choose **Config > System > Backup > Backup & Import**.

Configuration backup: Click **Backup** to download a configuration file locally.

Configuration import: Click **Browse**, select a backup file on the local PC, and click **Import** to import the configuration file. The device will restart.

i If the target version is much later than the current version, some configuration may be missing.

1. Before importing the configuration file, you are advised to [Reset](#) the device.
2. After the configuration file is imported, the device will reboot automatically.

Backup Config ?

Backup Config

Import Config ?

File Path

6.9 Restoring Factory Settings

6.9.1 Restoring the Current Device to Factory Settings

Choose **One-Device**. Click the device model, and choose **Config > System > Backup > Reset**.

Click **Reset** to restore the current device to the factory settings.

Backup & Import [Reset](#)

i You can reset the device to factory settings by clicking the Factory Reset button below. If you want to retain the current configuration while performing a factory reset, then [back up the profile](#) the configuration file prior to the reset. ?

Backup & Import [Reset](#)

i You can reset the device to factory settings by clicking the Factory Reset button below. If you want to retain the current configuration while performing a factory reset, then [back up the profile](#) the configuration file prior to the reset. ?

Tips ×

! Resetting the device will clear the current settings and reboot the device. Do you want to continue?

⚠ Caution

The operation will clear all configuration of the current device. If you want to retain the current configuration, back up the configuration first (See [6.8 Configuring Backup and Import](#)). Therefore, exercise caution when performing this operation.

6.9.2 Restoring All Devices to Factory Settings

In the self-organizing network mode, all devices in the network will be restored to factory settings.

Access the configuration page:

- Choose **Network-Wide > System > Reset**.
- Choose **Network-Wide > Workspace > Network-Wide > Reset**.

Click **All Devices**, select whether to enable **Retain bound account** and Click **Reset All Devices**. All devices in the network will be restored to factory settings.

i You can reset the device to factory settings by clicking the Factory Reset button below. If you want to retain the current configuration while performing a factory reset, then [back up the profile](#) the configuration file prior to the reset. **?**

Select master device All Devices

Retain bound account [Selecting this checkbox will allow the cloud account to maintain its project management privileges without requiring you to rebind your account.](#)

Reset All Devices

⚠ Caution

The operation will clear all configuration of all devices in the network. If you want to retain the current configuration, back up the configuration first (See [6.8 Configuring Backup and Import](#)). Therefore, exercise caution when performing this operation.

6.9.3 Restoring Master Device to Factory Settings

Access the configuration page:

- Choose **Network-Wide > System > Reset**.
- Choose **Network-Wide > Workspace > Network-Wide > Reset**.

Select **master device**, and check or uncheck the box next to **Retain bound account**. Then, click **Reset**. The master device will be restored to factory settings.

i You can reset the device to factory settings by clicking the Factory Reset button below. If you want to retain the current configuration while performing a factory reset, then [back up the profile](#) the configuration file prior to the reset. **?**

Select master device All Devices

Retain bound account [Selecting this checkbox will allow the cloud account to maintain its project management privileges without requiring you to rebind your account.](#)

Reset

⚠ Caution
 This operation will clear the current settings of the master device on the network and reboot the device. If you want to retain the current configuration, back up the configuration first (See [6.8 Configuring Backup and Import](#)). Therefore, exercise caution when performing this operation.

6.10 Performing Upgrade and Checking System Version

⚠ Caution

- You are advised to back up the configuration before upgrading the access point.
- After being upgraded, the access point will reboot. Therefore, exercise caution when performing this operation.

6.10.1 Online Upgrade

Access the configuration page:

- Upgrade master device on the network: Choose **Network-Wide > Workspace > Network-Wide > Upgrade > Online Upgrade**.
- Upgrade local device: Choose **One-Device**. Click the device model, and choose **Config > System > Upgrade > Online Upgrade**.

You can view the current system version. If there is a new version available, you can click it for an update.

[Online Upgrade](#) Local Upgrade

i Online upgrade will keep the current configuration. Please do not refresh the page or close th

Current Version ReyeeOS

New Version **ReyeeOS**

Description 1.

2.

Tip 1. If your device cannot access the Internet, please click [Download File](#).

2. Choose [Local Upgrade](#) to upload the file for local upgrade.

Upgrade Now

6.10.2 Local Upgrade

Access the configuration page:

- Upgrade master device on the network: Choose **Network-Wide > Workspace > Network-Wide > Upgrade > Local Upgrade**.
- Upgrade local device: Choose **One-Device**. Click the device model, and choose **Config > System > Upgrade > Local Upgrade**.

You can view the current software version, hardware version and device model. If you want to upgrade the device with the configuration retained, check **Retain Configuration**. Click **Browse**, select an upgrade package on the local PC, and click **Upload** to upload the file. The device will be upgraded.

Online Upgrade Local Upgrade

? systool.upgradeWarningTip

Model

Current Version ? ReyeeOS

Retain Configuration ? (If the target version is much later than the current version, you are advised not to retain the configuration.)

File Path ?

6.11 Switching System Language

Choose **English** in the upper right corner of the Web page.

Click a required language to switch the system language.

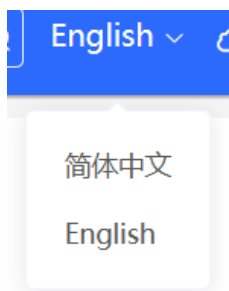

6.12 Configuring LED Status Control

⚠ Caution

The LED Status Control function is not supported in the local device mode (self-organizing network is not enabled).

Choose **Network-Wide > Workspace > Wireless > LED**.

Turn on the LED of all downlink access points in the network.

 Control the LEDs of all wireless devices on the network.

Enable

Save

6.13 Configuring Cloud Service

6.13.1 Overview

The Cloud Service feature provides powerful remote network management and operation capabilities, making it convenient and efficient to manage geographically dispersed networks with diverse device types. This feature supports wireless devices, switches, and gateways, enabling unified network management and visualized monitoring and operation. Additionally, it also offers various components such as real-name authentication, dedicated Wi-Fi, and passenger flow analysis, allowing for flexible expansion of network services.

By configuring Cloud Service, you can conveniently manage networks through Ruijie Cloud or the Ruijie Reyee app.

6.13.2 Configuration Steps

Choose **One-Device**. Click the device model, and choose **Config > System > Cloud Service**.

If the device is not currently associated with a cloud account, simply follow the on-screen instructions to add it to the network. Open up the Ruijie Reyee app, click the scan icon at the upper left corner on the **Project** page, and enter the device's management password.



Once the device is associated with a cloud account, it will automatically be bound to a cloud server based on its geographic location.

⚠ Caution

Exercise caution when modifying cloud service configurations as improper modifications may lead to connectivity issues between the device and the cloud service.

Cloud Server

China CloudConnected [Cancel](#)

This device is connected to Ruijie Cloud. The IP is 120.27.22.80, Exercise caution when modifying the cloud service configuration to ensure uninterrupted device connectivity.

Cloud Server [Reset](#)

* Domain Name [Configure IP](#)

IP Address

To change the Cloud Service configurations, select the cloud server from the **Cloud Server** drop-down list, enter the domain name and IP address, and click **Save**.

Note

If the server selected is not **Other Cloud**, the system automatically fills in the domain name and IP address of the cloud server. When **Other Cloud** is selected, you need to manually configure the domain name and IP address and upload the cloud server certificate.

Table 6-12 Cloud Server Description

Parameter	Description
Cloud Server	Geographic location of the cloud server, including China Cloud, Asia Cloud, Europe Cloud, America Cloud, and Other.
Domain Name	Domain name of the cloud server.
IP Address	IP address of the cloud server.

6.13.3 Unbinding Cloud Service

Choose **One-Device**. Click the device model, and choose **Config > System > Cloud Service**

You can click **Unbind** to unbind the account if you no longer wish to manage this project remotely.

Project Name:radio

Account:

Unbind the account if you no longer wish to manage this project remotely.

It is used to unbind all devices throughout the network. To unbind a single device, remove the device from the network and restore its default settings.

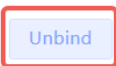

7 Network Diagnosis Tools

7.1 Network Check

When a network problem occurs on the device, perform a network check and configure the device based on the detection result.

Access the configuration page:

- Choose **Network-Wide > Workspace > Network-Wide > Diagnose**.
- Choose **One-Device**. Click the device model, and choose **Config > Diagnostics > Diagnose**.

(1) Click **Start** to perform the network check and show the result.

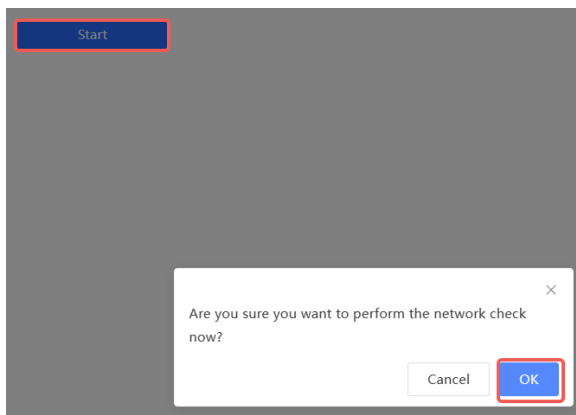

(2) After performing the network check, you will find the check result and suggested action.

IP Session Count
✓

DHCP Capacity
✓

Ruijie Cloud Server
!

Check Connection to Cloud Server

Result : The device is not connected with the cloud server. Cloud service may fail to start.

Suggestion : Please verify that the device SN is added to the cloud and check the network.

7.2 Network Tools

Choose **One-Device**. Click the device model, and choose **Config > Diagnostics > Network Tools**.

- The Ping tool tests the connectivity between the access point and the IP address or URL. The message "Ping failed" indicates that the access point cannot reach the IP address or URL.
- The Traceroute tool displays the network path to a specific IP address or URL.
- The DNS Lookup tool displays the DNS server address used to resolve a URL.

Enter an IP address or a URL, and click **Start**. If you need to perform the ping or Traceroute operation, configure other parameters as required.

Tool Ping Traceroute DNS Lookup

Type IPv4 IPv6

* IP Address/Domain

* Ping Count

* Packet Size Bytes

```

PING www.baidu.com (163.177.151.109): 64 data bytes
72 bytes from 163.177.151.109: seq=0 ttl=51 time=18.896 ms
72 bytes from 163.177.151.109: seq=1 ttl=51 time=18.686 ms
72 bytes from 163.177.151.109: seq=2 ttl=51 time=18.284 ms
72 bytes from 163.177.151.109: seq=3 ttl=51 time=20.310 ms
                    
```

Tool Ping Traceroute DNS Lookup

Type IPv4 IPv6

* IP Address/Domain

* Max TTL

```

traceroute to www.baidu.com (163.177.151.109), 20 hops
max, 46 byte packets
 1 192.168.111.1 (192.168.111.1) 0.621 ms 0.536 ms 0.548 ms
 2 172.20.74.1 (172.20.74.1) 2.271 ms 9.091 ms 8.565 ms
 3 172.20.255.109 (172.20.255.109) 2.974 ms 6.424 ms
10.932 ms
 4 * * *
 5 172.22.0.249 (172.22.0.249) 1.902 ms 1.453 ms 1.081 ms
 6 112.111.60.97 (112.111.60.97) 3.215 ms 3.290 ms 2.794 ms
 7 218.104.229.69 (218.104.229.69) 2.890 ms 2.639 ms
                    
```

Tool Ping Traceroute DNS Lookup

* IP Address/Domain

DNS

Result

7.3 Alerts

When a network exception occurs, the network overview page will display an alert and provide a suggestion. Click an alert in the **Alert Center** to view the faulty device, problem details, and description. You can troubleshoot the fault based on the suggestion.

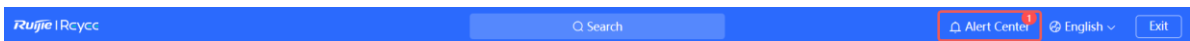

The **Alert List** page displays possible problems on the network environment and device. All types of alarms are followed by default. You can click **Unfollow** in the **Action** column to unfollow this type of alarm.

Caution

After unfollowing a specified alert type, you will not discover and process all alerts of this type promptly. Therefore, exercise caution when performing this operation.

View and manage alarms.

Alert List [View Unfollowed Alert](#)

Expand	Alerts	Suggestion	Action		
▼	Power supply is insufficient.	Under voltage may affect device performance or cause device reboot. Please check the power supply of device.	Delete Unfollow		
Device Name	SN	Type	Time	Details	Action
Ruijie	G1SK34H004233	RAP6260(H)-D	2023-12-06 15:33:10	Currently, 802.3at PoE power supply is used. A PoE switch or power supply module compliant with IEEE 802.3bt standard is needed to provide power for the device.	Delete

Total 1 < 1 > 10/page

Are you sure you want to unfollow the alarm and delete it from the alarm list?

1. After being unfollowed, an alarm will not appear again.
2. You can click [View Unfollowed Alert](#) to re-follow an unfollowed alarm.

Click **View Unfollowed Alert** to view the unfollowed alert. You can follow the alert again in the pop-up window.

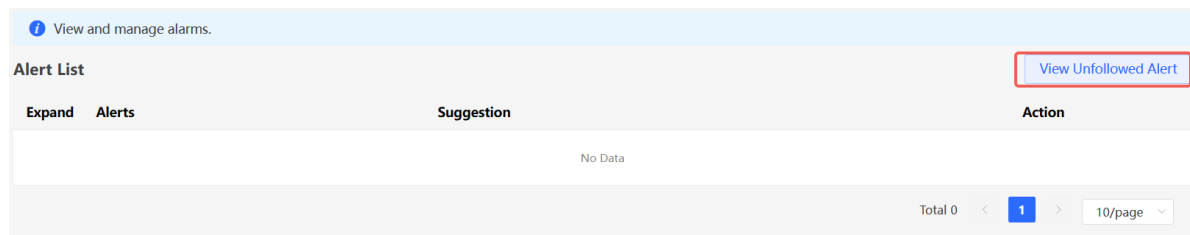

View Unfollowed Alert

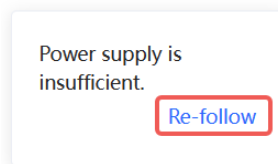

7.4 Fault Collection

Choose **One-Device**. Click the device model, and choose **Config > Diagnostics > Fault Collection**.

When an unknown fault occurs on the device, you can collect fault information on this page. Click **Start** to collect fault information and compress it into a file for engineers to identify fault.

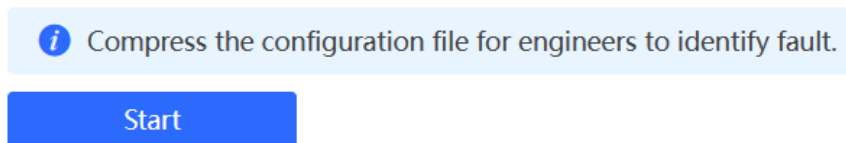

7.5 Packet Capturing

Choose **One-Device**. Click the device model, and choose **Config > Diagnostics > Packet Collection**.

If the device fails and troubleshooting is required, the packet capture result can be analyzed to locate and rectify the fault.

Select an interface and a protocol and specify the host IP address to capture the content in data packets. Select the file size limit and packet count limit to determine the conditions for automatically stopping packet capture. (If the file size or number of packets reaches the specified threshold, packet capture stops and a diagnostic package download link is generated.)

⚠ Caution

The packet capture operation may occupy excessive system resources, causing network freezing. Therefore, exercise caution when performing this operation.

If you have not installed the packet capture component, you need to download it from the cloud by clicking **Download Component Package**.

i Tips: Feature to be initialized. Download the component package from Ruijie Cloud! [Download Component Package](#)

Interface

Protocol

IP

MAC

File Size Limit MB

Packet Count Limit

The downloaded component package takes effect automatically. Click **Start** to execute the packet capture command.

i Packet Capture

Interface

Protocol

IP

MAC

File Size Limit MB

Packet Count Limit

Wireless Sniffing

[Delete Component Package](#)

Packet capture can be stopped at any time. After that, a download link is generated. Click this link to save the packet capture result in the PCAP format locally. Use analysis software such as Wireshark to view and analyze the result.

i Packet Capture

Interface

Protocol

IP

MAC

File Size Limit MB

Packet Count Limit

Wireless Sniffing

PCAP file [Click to download the PCAP file.](#) **i** [Click to delete the file.](#)

[Delete Component Package](#)

⚠ Caution

If the preceding troubleshooting steps fail to resolve the issue, and remote assistance from technical support is needed, you can contact them to assist in enabling the developer mode. The technical support team can then perform diagnostics to identify and address the issue effectively.

8 FAQs

8.1 Login Failure

➤ **What can I do when I failed to log in to the web interface?**

Perform the following steps:

- (1) Check that the Ethernet cable is properly connected to the LAN port of the device.
- (1) Before accessing the setup page, you are advised to choose **Auto** for the device enabled with DHCP service to assign an IP address to the PC. If you want to configure a static IP address for the PC, please make sure the IP address of the PC and the LAN port are in the same IP range. The default IP address of the LAN port is 10.44.77.254, and the subnet mask is 255.255.255.0. The IP address of the PC should be set to 10.44.77.X (X is an integer between 2 and 254), and the subnet mask is 255.255.255.0.
- (2) Run the **Ping** command to check the connectivity between the PC and the device. If the ping fails, please check the network settings.
- (3) If the login failure persists, restore the device to factory settings.

8.2 Factory Setting Restoration

➤ **How can I restore the device to factory settings?**

Power on the device and press the **Reset** button for more than 5 seconds. The device is restored to factory settings after it is restarted. Then, you can log in to the web interface using the default IP address (10.44.77.254).

8.3 Password Loss

➤ **What can I do when I forget the password?**

- Webpage management password loss: Please enter the Wi-Fi password. If it is still incorrect, please restore the device to factory settings.
- Wi-Fi password loss: When the access point expands the Wi-Fi coverage, its Wi-Fi password is consistent with that of the master router. Please check the configuration of the master router and enter its Wi-Fi password. If the password is still incorrect, please restore the device to factory settings and reconfigure the Wi-Fi password.